

## 1. Test conditions

RF power	0	dBm
Room Temperature	23	°C
Terminating source impedance (ZS):	50	Ω
Terminating load impedance (ZL):	50	Ω

## 2. Specifications

	Minimum	Typical	Maximum	Unit
Centre frequency		454.99		MHz
Pass Band	452.5		457.48	MHz
Insertion Loss in Pass Band		2	2.8	dB
VSWR in Pass Band		1.3:1	1.5:1	
Absolute Rejection				
0.3 MHz – 442.59 MHz	28	30		dB
462.5 MHz – 467.5MHz	35	45		dB
462.5 MHz – 467.5 MHz*)	40	45		dB
467.5 MHz – 1565 MHz	28	34		dB
1565 MHz – 1585 MHz	32	35		dB
1585 MHz – 2200 MHz	32	35		dB
Maximum Power (452.5MHz-457.48MHz)			+27	dBm
Operating temperature range	-30		+85	°C
Storage temperature range	-40		+100	°C
Temperature coefficient of frequency		-30		ppm/°C

\*) Temperature Range -10...+60°C

	<b>SIPAT Co., Ltd.</b> ( CETC No. 26 Research Institute ) Nanping Huayuan Road No. 14 Chongqing, China, 400060	Part Number	SF455B	
		Rev. Date	2006-7-11	
		Rev.	PR1.0	Page

### 3. Matching Network



### 4. Package Dimension

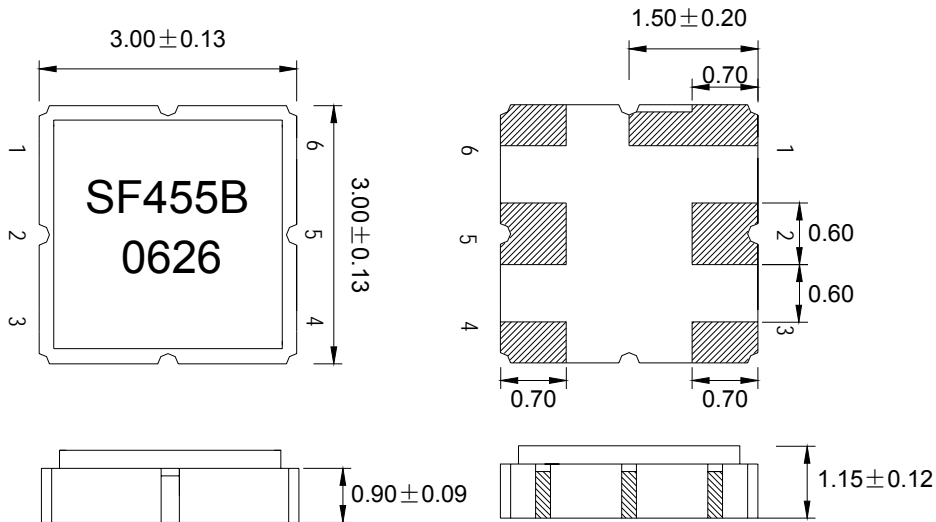



- Pin1     Ground
- Pin2     Input
- Pin3     Ground
- Pin4     Ground
- Pin5     Output
- Pin6     Ground

	<b>SIPAT Co., Ltd.</b> ( CETC No. 26 Research Institute ) Nanping Huayuan Road No. 14 Chongqing, China, 400060	Part Number	SF455B	
		Rev. Date	2006-7-11	
		Rev.	PR1.0	Page

### 5. Typical Performance

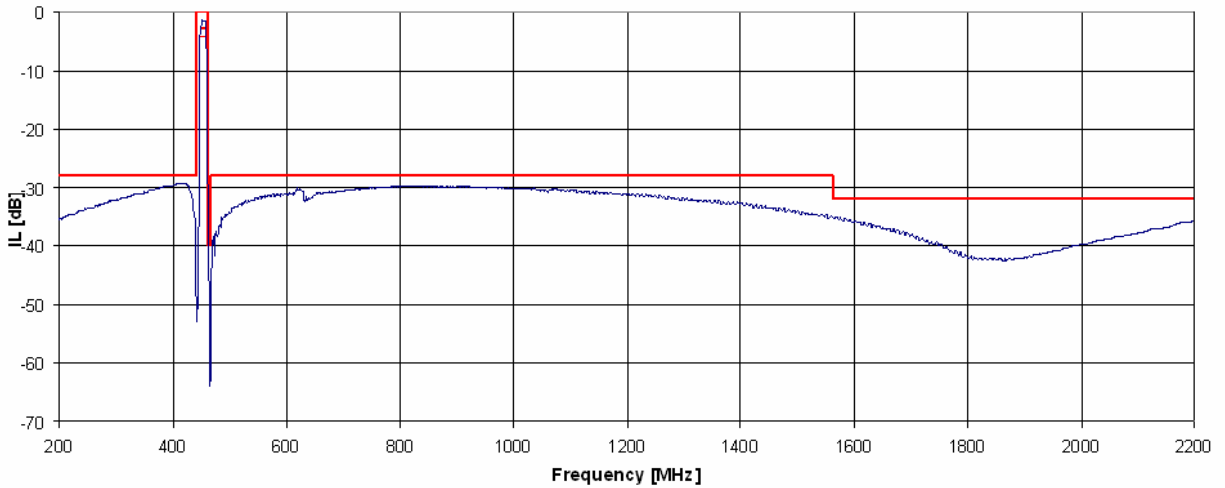
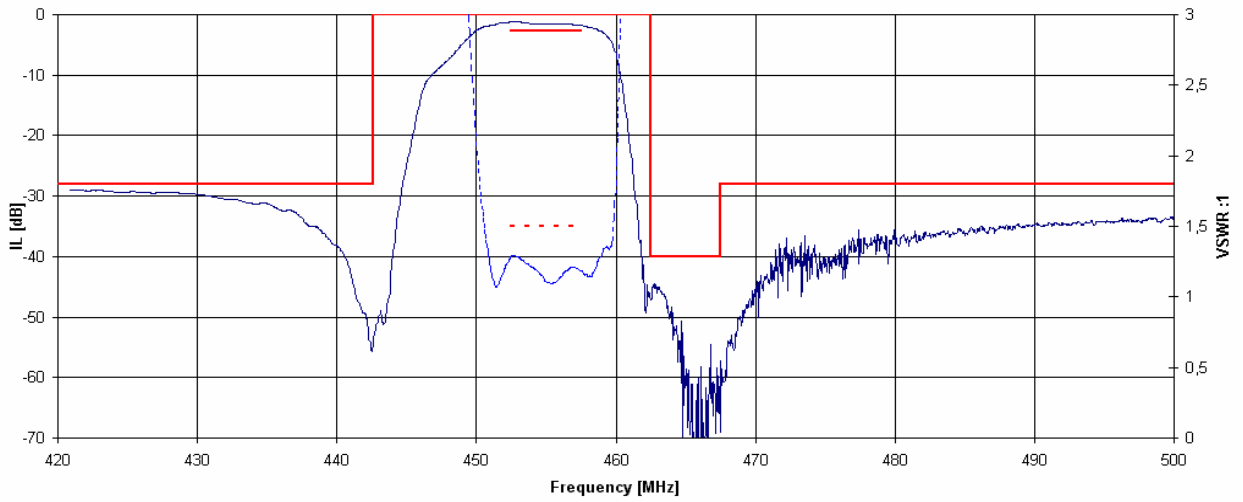
Frequency response



	<b>SIPAT Co., Ltd.</b> ( CETC No. 26 Research Institute ) Nanping Huayuan Road No. 14 Chongqing, China, 400060	Part Number	SF455B
		Rev. Date	2006-7-11
		Rev.	PR1.0

VSWR

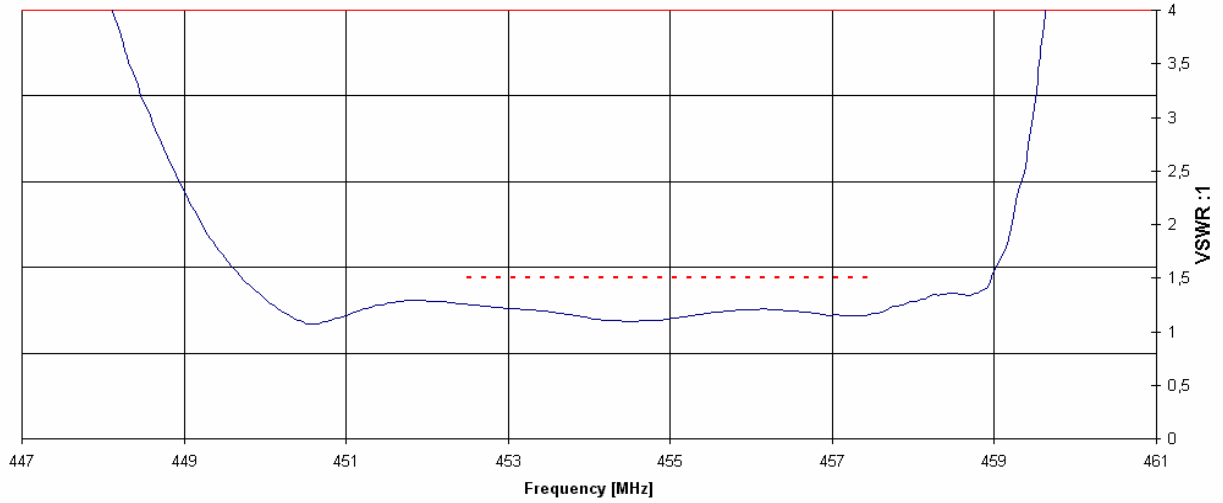

**6. Tape & Reel:**

**1.1 Packing**

The product shall be properly packed to avoid damaged during transportation and storage.

**1.2 Dimensions**

- 1.2.1 Carrier Tape: see Figure 1
- 1.2.2 Reel: see Figure 3

**1.3 Reeling Quantity**

3.000 pcs/reel

**1.4 Taping Structure**

**1.4.1 Tape & Reel Orientation**

The tape shall be wound around the reel in the direction shown below.

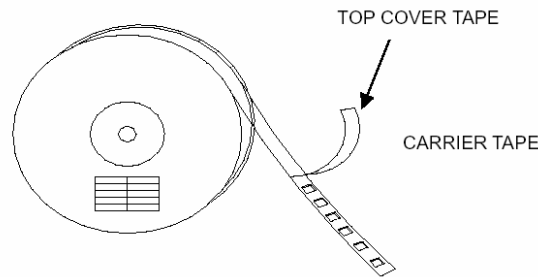

**Figure 1 Taping Structure**

	<b>SIPAT Co., Ltd.</b> ( CETC No. 26 Research Institute ) Nanping Huayuan Road No. 14 Chongqing, China, 400060	Part Number	SF455B	
		Rev. Date	2006-7-11	
		Rev.	PR1.0	Page 4/6

1.4.2 Label

Device name	S.....
Quantity	3.000
Datecode	

1.4.3 Leader part and vacant position specifications.

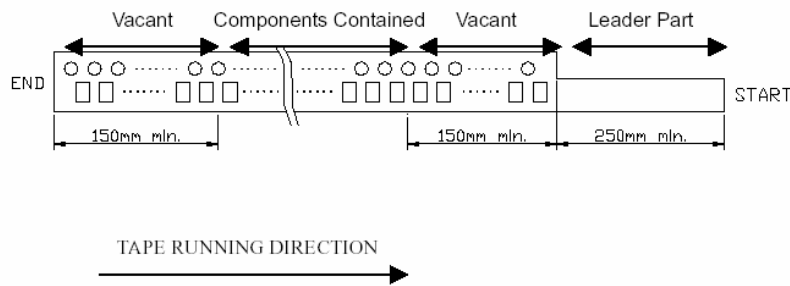
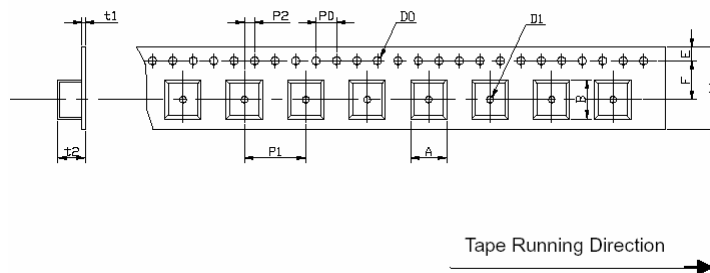
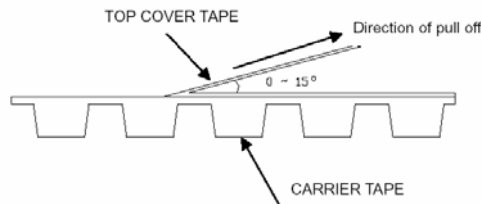



Figure 2 2 Leader specification

1.4.4 Tape Specifications

- Tensile Strength of Carrier Tape: 4.4N/mm width
- Top Cover Tape Adhesion (see figure below)
  - pull off angle: 0~15°
  - speed : 300mm/min.
  - force : 20~70g



	<b>SIPAT Co., Ltd.</b> ( CETC No. 26 Research Institute ) Nanping Huayuan Road No. 14 Chongqing, China, 400060	Part Number	SF455B
		Rev. Date	2006-7-11
		Rev.	PR1.0

**Figure 3 Carrier Tape Dimensions**

W	F	E	P0	P1	P2	D0	D1	t1	t2	A	B
12.0	5.5	1.75	4.0	4.0	2.0	Φ1.5	Φ1.5	0.31	1.95	3.3	3.3
±0.3	±0.1	±0.1	±0.2	±0.1	±0.2	±0.1	±0.25	max.	max.	±0.1	±0.1

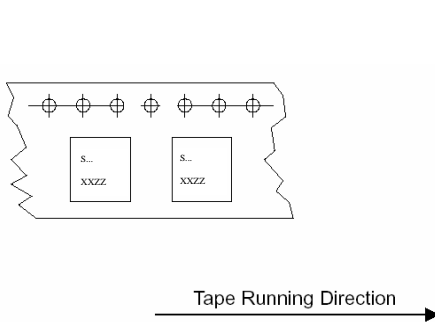

**Figure 4 Part Direction**

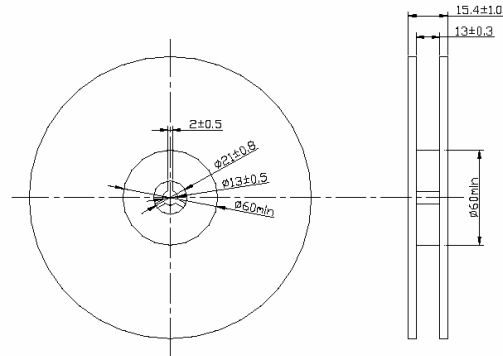

**Figure 5 Reel Dimensions**

**Remarks**

1 Static voltage:

Static voltage between signal load & ground may cause deterioration & destruction of the component. Please avoid static voltage.

2.Ultrasonic cleaning:

Ultrasonic vibration may cause deterioration & destruction of the component. Please avoid ultrasonic cleaning.

3 Soldering:

Only leads of component may be soldered. Please avoid soldering other parts of component.

	<b>SIPAT Co., Ltd.</b> ( CETC No. 26 Research Institute ) Nanping Huayuan Road No. 14 Chongqing, China, 400060	Part Number	SF455B
		Rev. Date	2006-7-11
		Rev.	PR1.0