

1. Test conditions

RF power	0	dBm
Room Temperature	23	°C
Terminating source impedance (ZS):	50	Ω
Terminating load impedance (ZL):	50	Ω

2. Specifications

	Minimum	Typical	Maximum	Unit
Centre frequency		464.99		MHz
Pass Band	462.5		467.48	MHz
Insertion Loss in Pass Band		2.2	3.8	dB
VSWR in Pass Band		1.5:1	2.0:1	
Absolute Rejection				
0.3 MHz – 452.5MHz	48	55		dB
TX Rejection				
452.5 MHz – 457.48 MHz	35	43		dB
452.5 MHz – 457.48 MHz *)	40	43		dB
Rejection 900 MHz Cellular				
485 MHz – 1000 MHz	40	45		dB
1000 MHz – 2000 MHz	30	37		dB
Rejection PCS DCS UMTS				
2000 MHz – 2200 MHz	25	27		dB
Operating temperature range	-30		+85	°C
Temperature coefficient of frequency		-30		ppm/°C
Input Power			27	dBm

*) Temperature Range: -10 ... +60C°

3. Matching Network

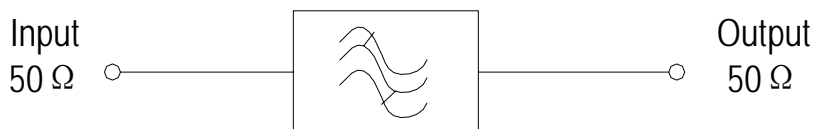

	SIPAT Co., Ltd. (CETC No. 26 Research Institute) Nanping Huayuan Road No. 14 Chongqing, China, 400060	Part Number	SF465C	
		Rev. Date	2005-2-14	
		Rev.	PR6.0	Page

4. Package Dimension

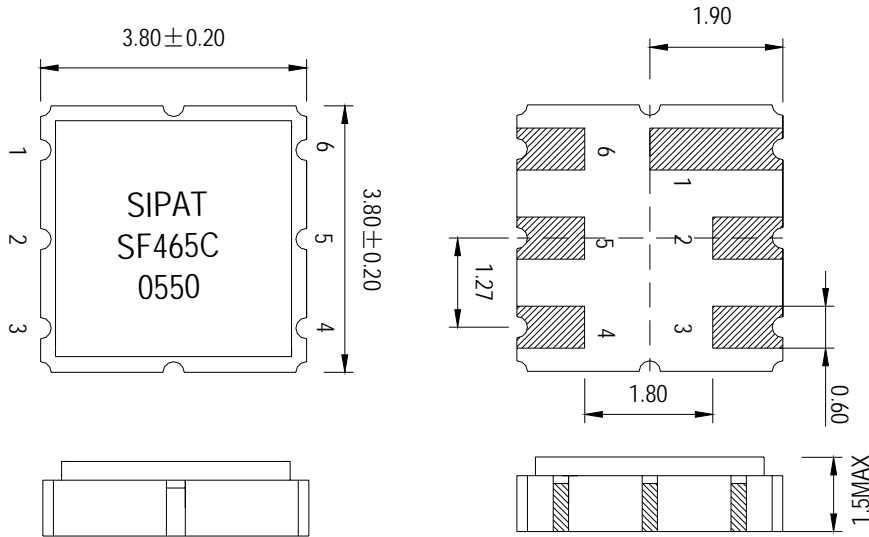

Pin No.	Function
2.	Input
5.	Output
Other	Ground

*Dimensions shown are nominal in millimeters

Body : Al₂O₃ Ceramic / Lid : Kovar, Ni Plated

Terminations : Au plating 0.3 ~ 1.0 um, Over a 1.27 ~ 8.89 um

Ni Plating

5. Marking Configuration

- 1) *
- 2) SIPAT
- 3) SF465C
- 4) 0550

- 1) Pad Number 1 Index
- 2) Manufacturer name
- 3) Part Number
- 4) Date Code

	SIPAT Co., Ltd. (CETC No. 26 Research Institute) Nanping Huayuan Road No. 14 Chongqing, China, 400060	Part Number	SF465C
		Rev. Date	2005-2-14
		Rev.	PR6.0

6. Typical Performance

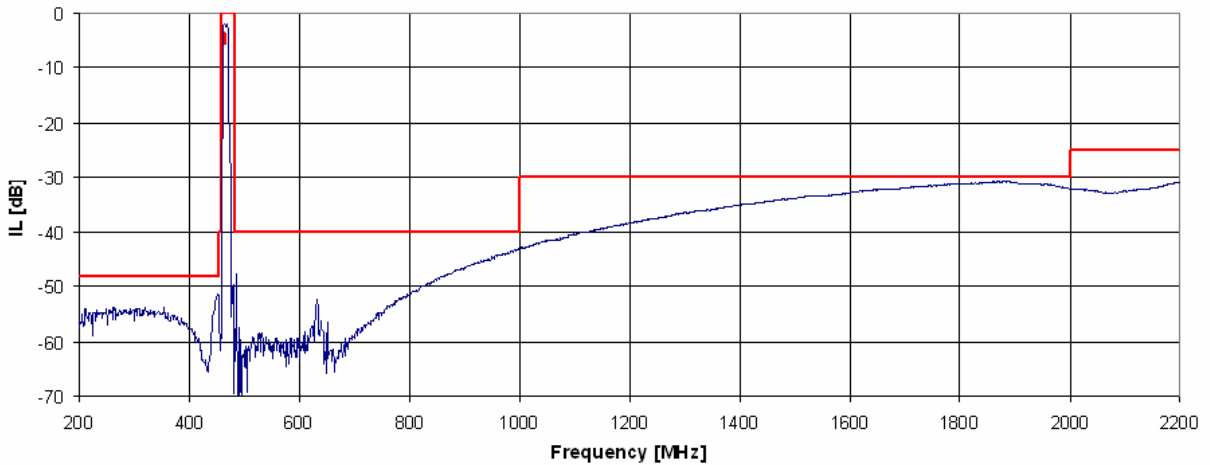
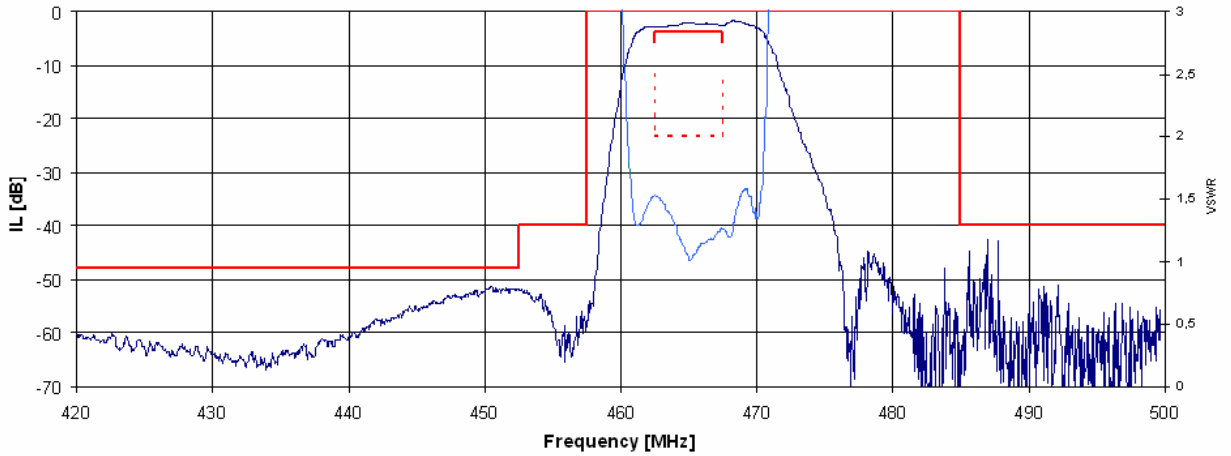

	SIPAT Co., Ltd. (CETC No. 26 Research Institute) Nanping Huayuan Road No. 14 Chongqing, China, 400060	Part Number	SF465C
		Rev. Date	2005-2-14
		Rev.	PR6.0

7. Packing

1. Reeling Quantity : 3000 pcs / 13" reel (or 1000 pcs / 7" reel)
2. Taping Structure : The tape shall be wound around the reel in the direction shown below.

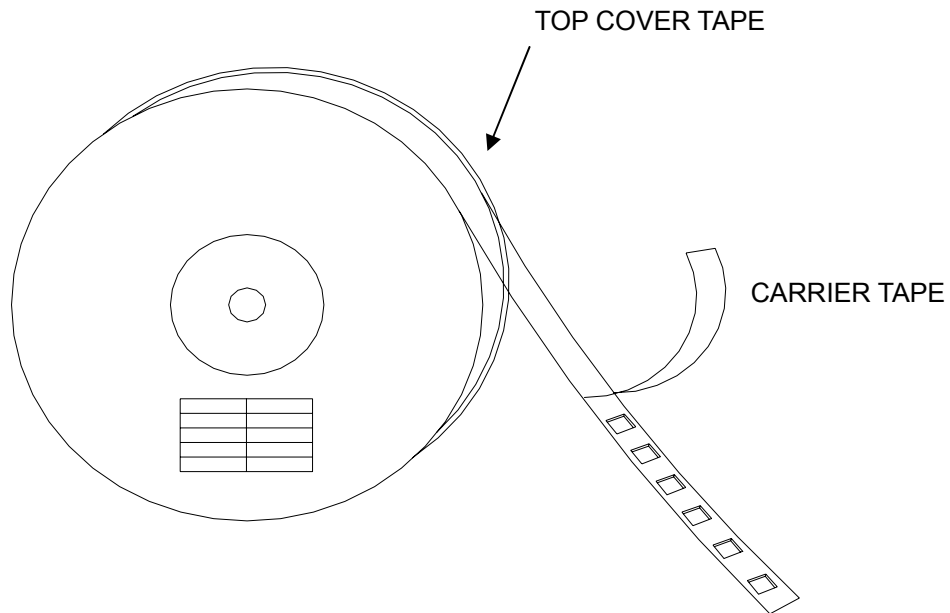
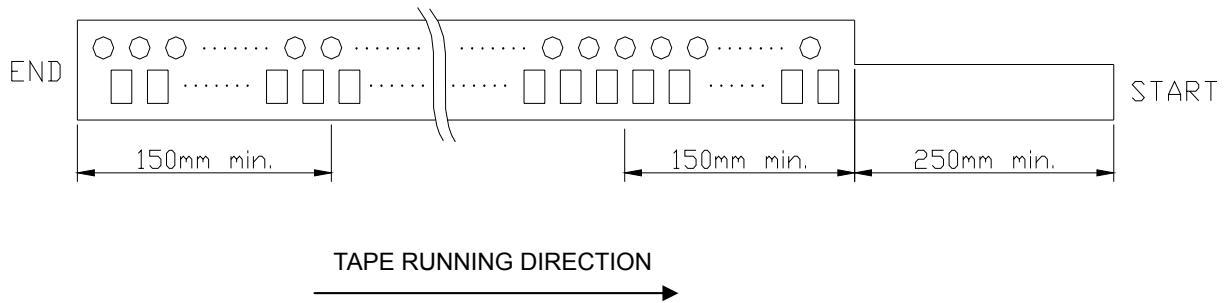

	SIPAT Co., Ltd. (CETC No. 26 Research Institute) Nanping Huayuan Road No. 14 Chongqing, China, 400060	Part Number	SF465C	
		Rev. Date	2005-2-14	
		Rev.	PR6.0	Page

3. Top Cover Tape Adhesion (See the below figure)

- (1) pull off angle: 0~15°
- (2) speed: 300mm/min
- (3) force: 20~70g

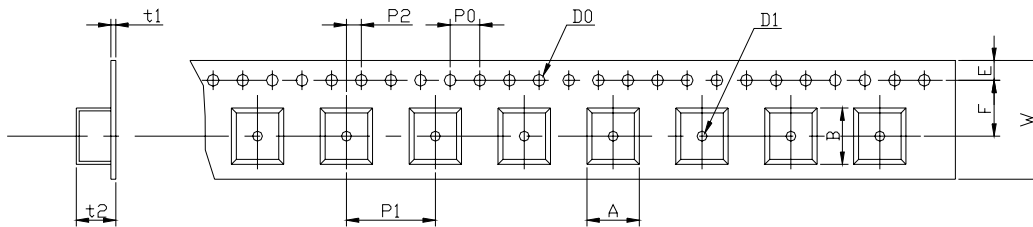
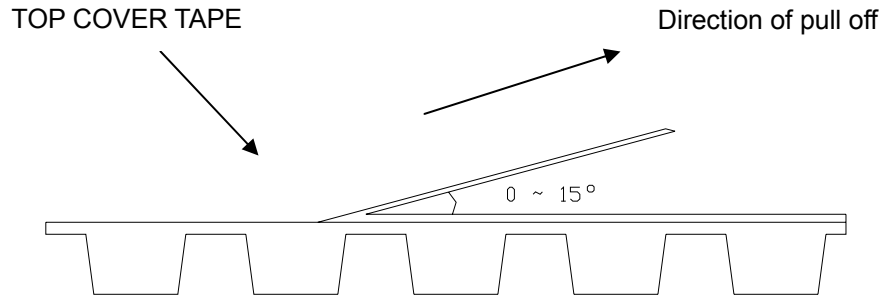

W	F	E	P0	P1	P2	D0	D1	t1	t2	A	B
12.0	5.5	1.75	4.0	8.0	2.0	Φ1.5	Φ1.5	0.31	1.95	4.1	4.1
±0.3	±0.1	±0.1	±0.2	±0.1	±0.2	±0.1	±0.25	max.	max.	max.	max.

	SIPAT Co., Ltd. (CETC No. 26 Research Institute) Nanping Huayuan Road No. 14 Chongqing, China, 400060	Part Number	SF465C	
		Rev. Date	2005-2-14	
		Rev.	PR6.0	Page 5/6

4. Reel Dimensions

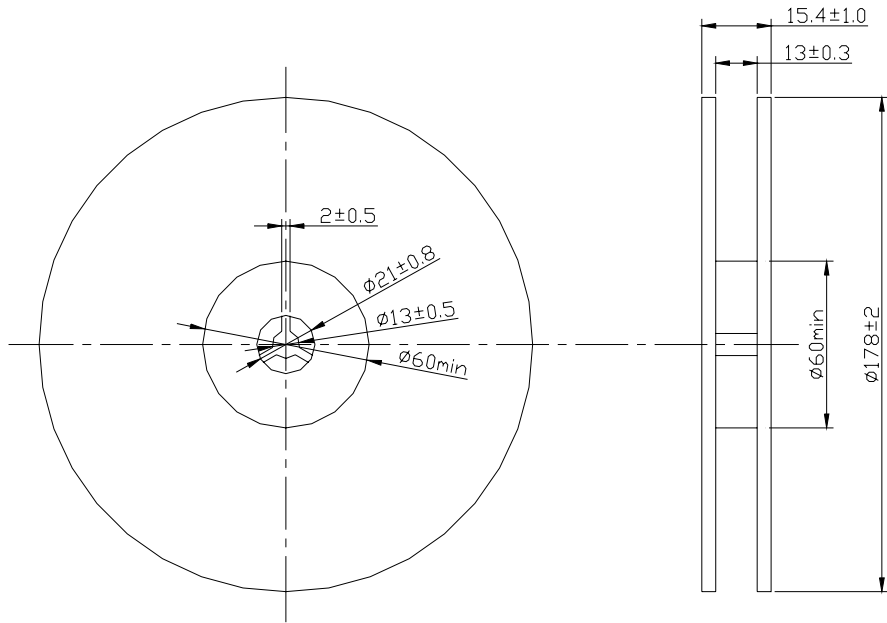

[Unit: mm]

5. Part Direction

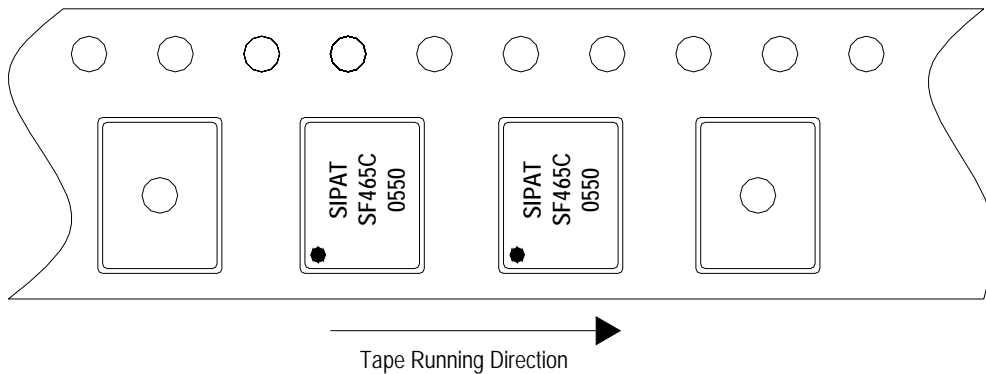

	SIPAT Co., Ltd. (CETC No. 26 Research Institute) Nanping Huayuan Road No. 14 Chongqing, China, 400060	Part Number	SF465C	
		Rev. Date	2005-2-14	
		Rev.	PR6.0	Page