

Specifications

| Parameter | Unit | Minimum | Typical | Maximum |
|---|-------------|---------|---------|---------|
| Center Frequency | MHz | - | 750 | - |
| Insertion Loss | dB | - | 2 | 5 |
| 1 dB Bandwidth | MHz | - | 33 | - |
| 3 dB Bandwidth | MHz | 50 | 49.98 | - |
| 35 dB Bandwidth | MHz | - | 125.88 | 55 |
| Passband Variation($f_0 \pm 20\text{MHz}$) | dB | - | 0.1 | 1 |
| Absolute Delay | usec | - | 0.02 | - |
| Group Delay Variation($f_0 \pm 20\text{MHz}$) | nsec | - | 8 | 20 |
| Ultimate Rejection | 640~720MHz | dB | 4 | 11 |
| | 780~860MHz | dB | 4 | 8 |
| | 1~640MHz | dB | 35 | 48 |
| | 860~1000MHz | dB | 35 | 50 |
| Material Temperature coefficient | KHz/°C | -51 | | |
| Ambient Temperature | °C | 25 | | |
| Package Size | SMD3.8*3.8 | | | |

Notes:

1. All specifications are based on the test circuit shown
2. In production, devices will be tested at room temperature to a guardbanded specification to ensure electrical compliance over temperature
3. Electrical margin has been built into the design to account for the variations due to temperature drift and manufacturing tolerances
4. This is the optimum impedance in order to achieve the performance show

Matching Configuration



Source/Load Impedance=50 ohm

Notes - Component values may change depending on board layout.



SIPAT Co., Ltd.
(CETC No. 26 Research Institute)
Nanping Huayuan Road No. 14
Chongqing, China, 400060

| | | | |
|-------------|------------|----------|--|
| Part Number | SP75001 | | |
| Rev. Date | 2007-04-30 | | |
| Ver. | 1.0 | Page 1/4 | |

Package Dimension

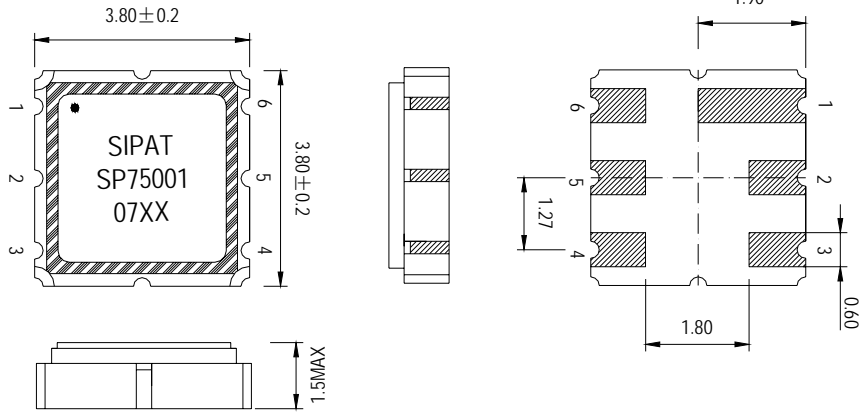

- 1) ∙: Pad Number 1 Index
- 2) SIPAT: Manufacturer name
- 3) SP75001: Part Number
- 4) 07XX: Date Code

| | |
|--------|---------|
| Input | 2 |
| Output | 5 |
| Ground | 1,3,4,6 |

Package: SMD3.8*3.8

Unit: mm



SIPAT Co., Ltd.
(CETC No. 26 Research Institute)
Nanping Huayuan Road No. 14
Chongqing, China, 400060

| | | |
|-------------|------------|----------|
| Part Number | SP75001 | |
| Rev. Date | 2007-04-30 | |
| Ver. | 1.0 | Page 2/4 |

Typical Performance

Frequency Response

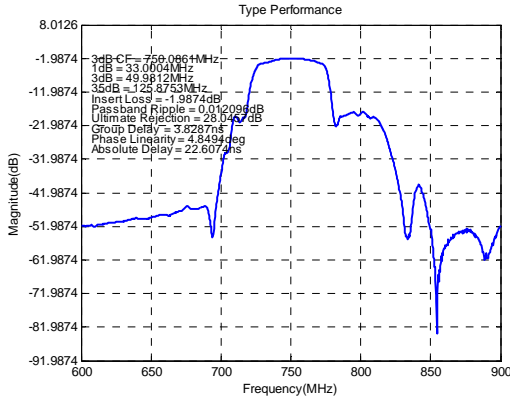

Horizontal: 50MHz/Div Vertical: 10dB/Div

Passband Response

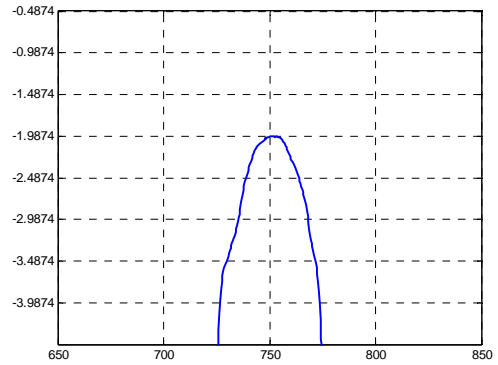

Horizontal: 50MHz/Div Vertical: 0.5dB/Div

Group Delay Variation (f0±20MHz)

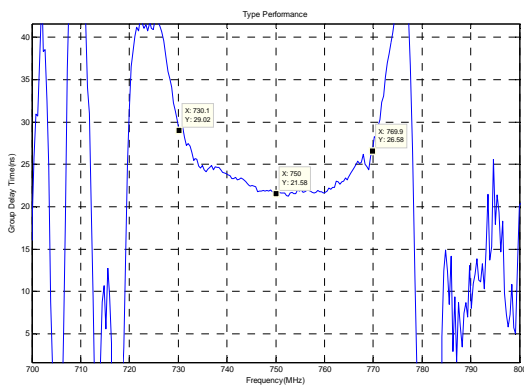

Horizontal: 10MHz/Div Vertical: 5ns/Div

Phase Linearity (f0±20MHz)

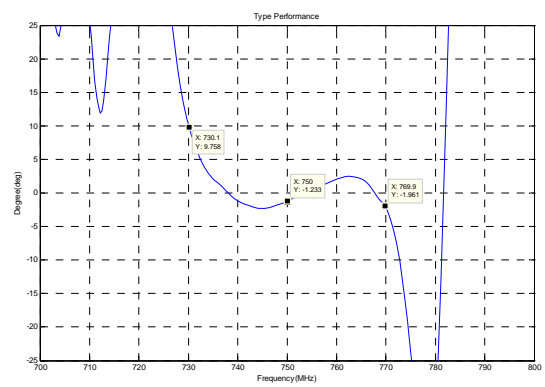

Horizontal: 10MHz/Div Vertical: 5deg/Div

Smith Chart S11

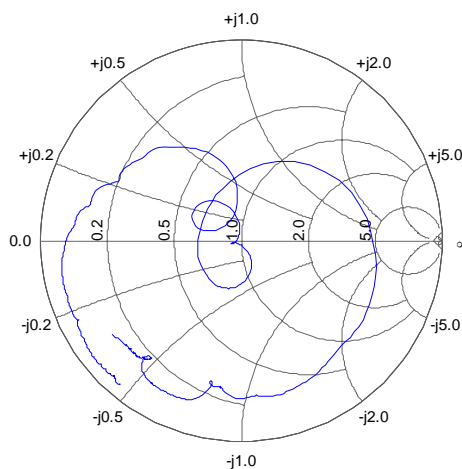

Smith Chart S22

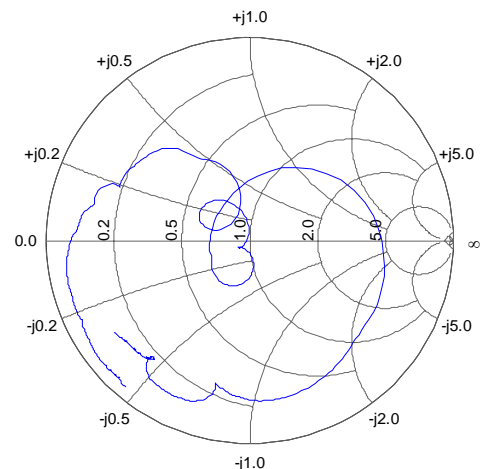

SIPAT Co., Ltd.
(CETC No. 26 Research Institute)
Nanping Huayuan Road No. 14
Chongqing, China, 400060

| | | |
|-------------|------------|----------|
| Part Number | SP75001 | |
| Rev. Date | 2007-04-30 | |
| Ver. | 1.0 | Page 3/4 |

Maximum Ratings

| | | |
|------------------------------------|-----|----------------|
| Operating Temperature Range | °C | [-40°C;+85°C] |
| Storage Temperature Range | °C | [-40°C;+105°C] |
| DC Voltage | V | 0 |
| Input Power | dBm | 10 max |
| ESD Class | | 1 |



SIPAT Co., Ltd.
(CETC No. 26 Research Institute)
Nanping Huayuan Road No. 14
Chongqing, China, 400060

| | | | |
|-------------|------------|------|-----|
| Part Number | SP75001 | | |
| Rev. Date | 2007-04-30 | | |
| Ver. | 1.0 | Page | 4/4 |