

1. MODEL NUMBER

MODEL NUMBER.	CUSTOMER PART NO.
DF765S32B	

2. TEST CONDITION

2-1 TYPICAL CONDITION : -TEMPERATURE : 20°C

-HUMIDITY : 65%RH

2-2 STANDARD CONDITION : -TEMPERATURE : -40°C to 85°C

-HUMIDITY : 45%RH to 85%RH

3. COMPOSITION AND MATERIAL

NO.	NAME	COMPOSITION AND MATERIALS
3-1	RESONATOR	DIELECTRIC MATERIALS
3-2	NUMBER OF POLE	2 POLE
3-3	IN/OUTPUT TERMINALS	Ag or Sn PLATED
3-4	GROUND BASE	Ag or Sn PLATED

4. ELECTRICAL SPECIFICATIONS

NO.	ITEM	SPECIFICATIONS
4-1	CENTER FREQUENCY(f_0)	765.0MHz
4-2	BAND WIDTH	± 16.0 MHz
4-3	INSERTION LOSS IN BW	2.5dB max.
4-4	RIPPLE	0.5dB max.
4-5	V.S.W.R IN BW	1.5 max.
4-6	ATTENUATION	30dB min. at 485MHz
4-7	INPUT POWER	1 W
4-8	NOMINAL CHARACTERISIC IMPEDANCE	50 Ω

	SIPAT Co., Ltd. (CETC No. 26 Research Institute) Nanping Huayuan Road No. 14 Chongqing, China, 400060	Part Number	DF765S32B	
		Rev. Date	2005-9-21	
		Rev.	1.0	Page

5. APPEARANCES AND DIMENSIONS

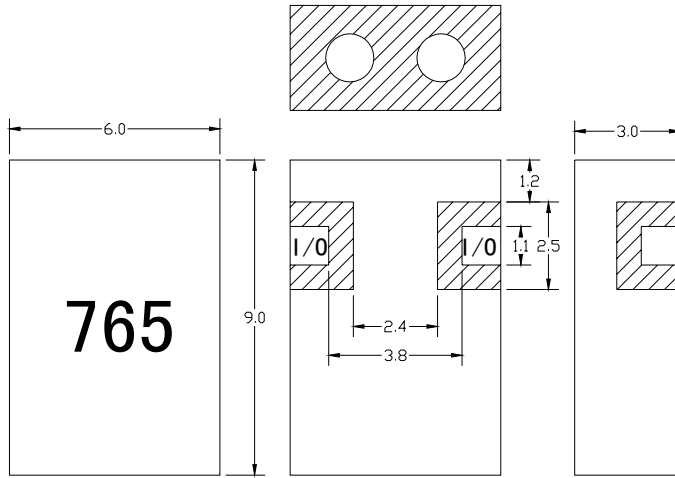

Tol: ±0.2
Unit:mm

6. RECOMMENDED REFLOW PAD

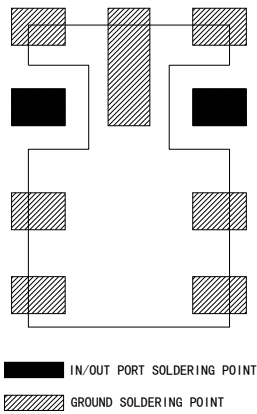

7. REFLOW SOLDERING STANDARD CONDITIONS

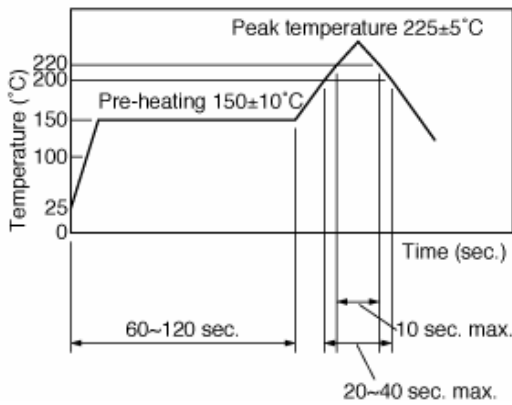

SIPAT Co., Ltd.
(CETC No. 26 Research Institute)
Nanping Huayuan Road No. 14
Chongqing, China, 400060

Part Number	DF765S32B	
Rev. Date	2005-9-21	
Rev.	1.0	Page 2/3

8.CHARACTERISTICS

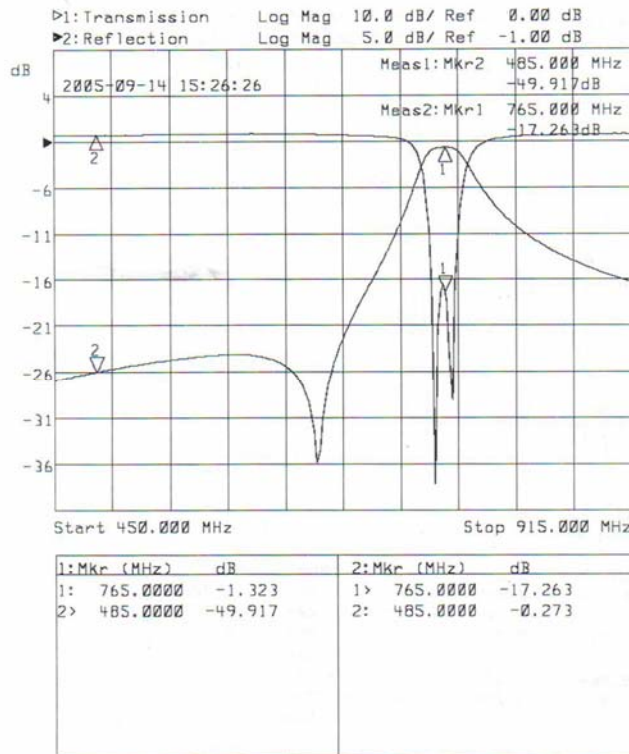
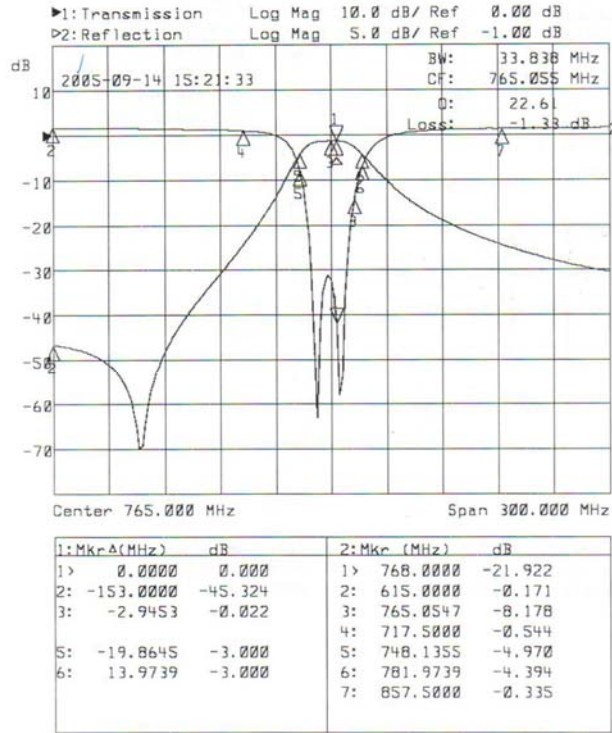

	SIPAT Co., Ltd. (CETC No. 26 Research Institute) Nanping Huayuan Road No. 14 Chongqing, China, 400060	Part Number	DF765S32B
		Rev. Date	2005-9-21
		Rev.	1.0