



### Features

- ◇ For IF SAW filter
- ◇ High attenuation
- ◇ Single-ended operation
- ◇ Dual In-line Package
- ◇ RoHS compliant (2002/95/EC), Pb-free

### Specifications

Parameter	Unit	Minimum	Typical	Maximum
Center Frequency	MHz	43.9	44	44.1
Insertion Loss	dB	-	24.5	25
1 dB Bandwidth	MHz	-	11.75	-
3 dB Bandwidth	MHz	12	12.78	-
40 dB Bandwidth	MHz	-	16.65	17
Passband Variation	dB	-	0.5	1
Absolute Delay	usec	-	1.49	-
Ultimate Rejection	dB	50	53	-
Material Temperature coefficient	KHz/°C	-3.61		
Substrate Material	-	128LN		
Ambient Temperature	°C	25		
Operating Temperature Range	°C	-40	-	+85
Storage Temperature Range	°C	-45	-	+105
DC Voltage	V	0		
Input Power	dBm	-	-	10
ESD Class	-	1A		
Package Size	DIP2712 (27.0x12.8x4.7mm3)			

#### Notes:

1. All specifications are based on the test circuit shown;
2. In production, all specifications are measured by Agilent Network analyzer and full 2 port calibration at room temperature;
3. Electrical margin has been built into the design to account for the variations due to temperature drift and manufacturing tolerances;
4. This is the optimum impedance in order to achieve the performance show.

	<b>SIPAT Co., Ltd.</b> ( CETC No.26 Research Institute ) #14 Nanping Huayuan Road, Chongqing, China, 400060	Part Number	LBN04403	
		Rev. Date	2008-01-21	
		Ver.	2.0	Page

### Matching Configuration

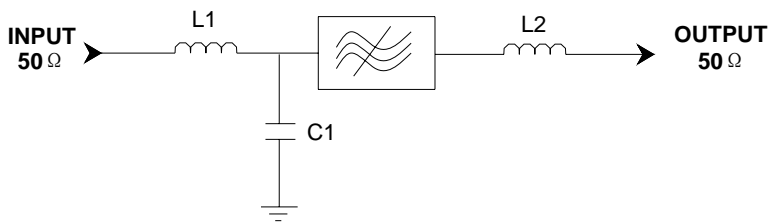

**L1=560nH L2=270nH**  
**C1=15pF**  
**Source/Load Impedance=50 ohm**

Notes - Component values may change depending  
on board layout.

### Package Dimension

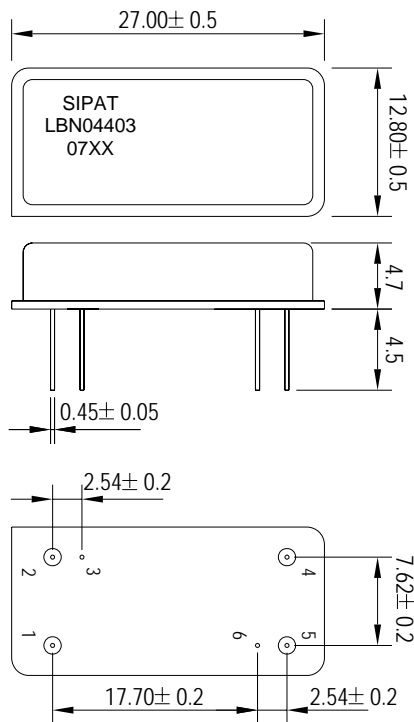

#### Pad Configuration:

Input 1  
Output 5  
Ground All Others

#### Marking Configuration:

- 1) SIPAT: Manufacturer Name
- 2) LBN04403: Part Number
- 3) 07XX: Date Code

**Package: DIP2712**

**Unit: mm**



**SIPAT Co., Ltd.**  
( CETC No.26 Research Institute )  
#14 Nanping Huayuan Road,  
Chongqing, China, 400060

Part Number	LBN04403	
Rev. Date	2008-01-21	
Ver.	2.0	Page 2/3



Typical Performance

Frequency Respond

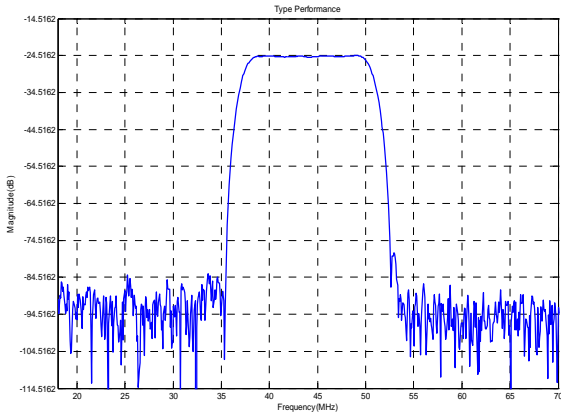

Horizontal: 5MHz/Div Vertical: 10dB/Div

Passband Respond

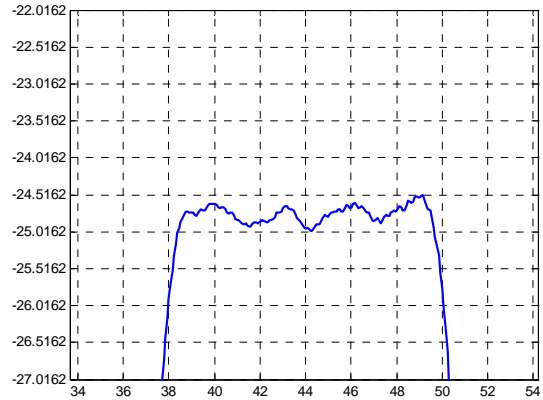

Horizontal: 2MHz/Div Vertical: 0.5dB/Div

Group Delay Variation( $f_0 \pm 6\text{MHz}$ )

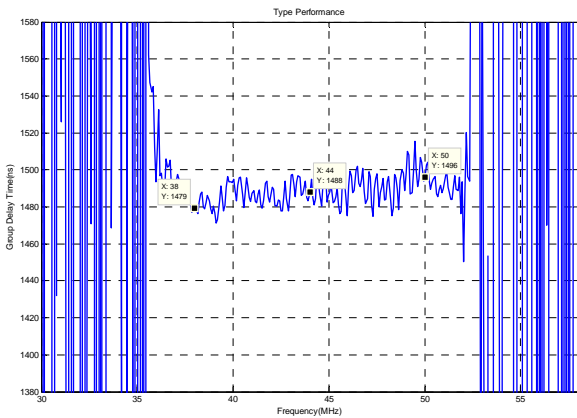

Horizontal: 5MHz/Div Vertical: 20ns/Div

Phase Linearity( $f_0 \pm 6\text{MHz}$ )

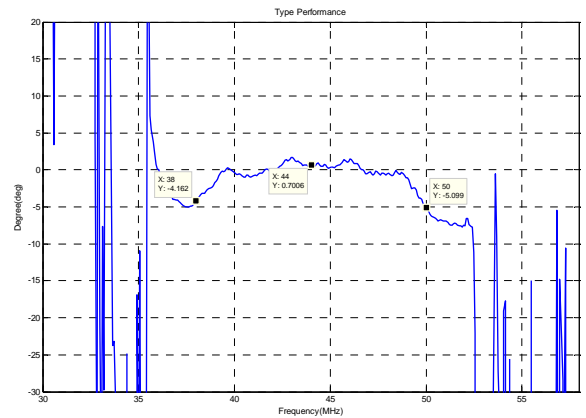

Horizontal: 5MHz/Div Vertical: 5deg/Div

Smith Chart S11

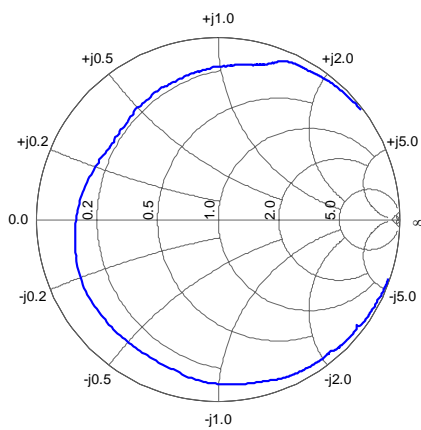

Smith Chart S22

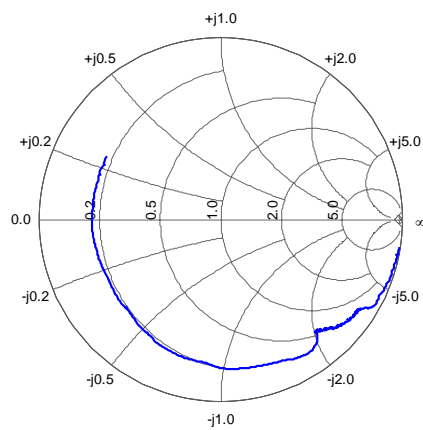

SIPAT Co., Ltd.  
( CETC No.26 Research Institute )  
#14 Nanping Huayuan Road,  
Chongqing, China, 400060

Part Number	LBN04403	
Rev. Date	2008-01-21	
Ver.	2.0	Page 3/3