



### Features

- ◇ For IF SAW filter
- ◇ High attenuation
- ◇ Dual In-line Package
- ◇ No matching required for operation at 50Ω
- ◇ RoHS compliant (2002/95/EC), Pb-free

### Specifications

Parameter	Unit	Minimum	Typical	Maximum	
Center Frequency	MHz	114.9	115	115.1	
Insertion Loss	dB	-	26.8	35	
2.5 dB Bandwidth	MHz	15	15.1	-	
3 dB Bandwidth	MHz	-	15.13	-	
40 dB Bandwidth	MHz	-	15.8	-	
Passband Variation	dB	-	1.3	-	
Absolute Delay	usec	-	3.67	4.5	
Ultimate Rejection	$f_0 \pm 7.9\text{MHz}$	dB	30	37	-
	$f_0 \pm 8.1\text{MHz}$	dB	45	53	-
	$f_0 \pm 8.5\text{MHz}$	dB	50	52	-
	$f_0 \pm 12.5\text{MHz}$	dB	50	53	-
Material Temperature coefficient	KHz/°C	-10.81			
Substrate Material	-	YZ LN			
Ambient Temperature	°C	25			
Operating Temperature Range	°C	-40	-	+85	
Storage Temperature Range	°C	-45	-	+105	
DC Voltage	V	0			
Input Power	dBm	-	-	10	
ESD Class	-	1			
Package Size	DIP3512 (35.0x12.8x4.7mm3)				

#### Notes:

1. All specifications are based on the test circuit shown;
2. In production, all specifications are measured by Agilent Network analyzer and full 2 port calibration at room temperature;
3. Electrical margin has been built into the design to account for the variations due to temperature drift and manufacturing tolerances;
4. This is the optimum impedance in order to achieve the performance show.

	<b>SIPAT Co., Ltd.</b> ( CETC No.26 Research Institute ) #14 Nanping Huayuan Road, Chongqing, China, 400060	Part Number	LBN11536	
		Rev. Date	2007-11-13	
		Ver.	2.0	Page 1/3

### Matching Configuration



Source/Load Impedance=50 ohm

Notes - Component values may change depending on board layout.

### Package Dimension

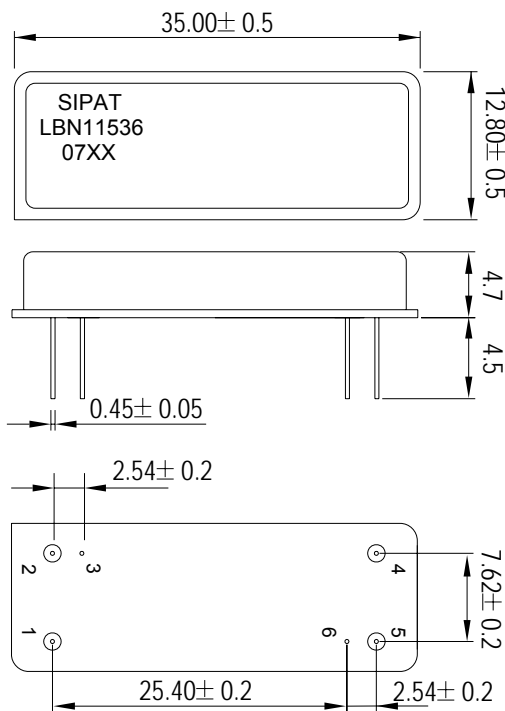

#### Pad Configuration:

Input 1  
 Output 5  
 Ground All Others

#### Marking Configuration:

- 1) SIPAT: Manufacturer Name
- 2) LBN11536: Part Number
- 3) 07XX: Date Code

Package: DIP3512

Unit: mm



**SIPAT Co., Ltd.**  
 ( CETC No.26 Research Institute )  
 #14 Nanping Huayuan Road,  
 Chongqing, China, 400060

Part Number	LBN11536	
Rev. Date	2007-11-13	
Ver.	2.0	Page 2/3

Typical Performance

Frequency Respond

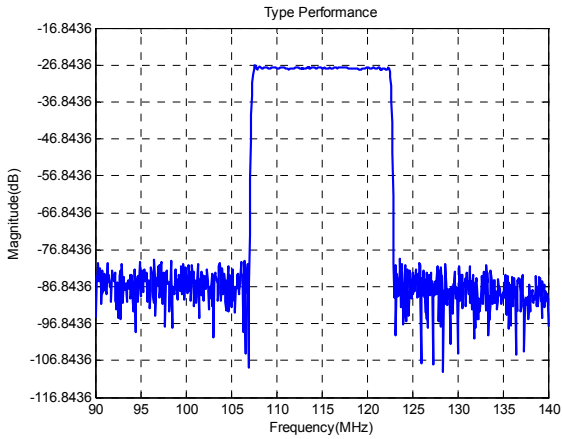

Horizontal: 5MHz/Div Vertical: 10dB/Div

Passband Respond

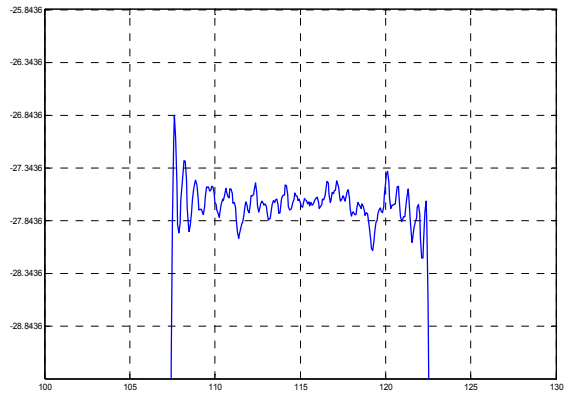

Horizontal: 5MHz/Div Vertical: 0.5dB/Div

Group Delay Variation( $f_0 \pm 7\text{MHz}$ )

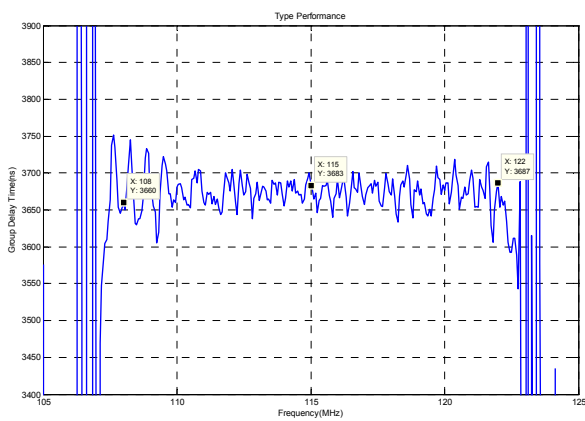

Horizontal: 5MHz/Div Vertical: 50ns/Div

Phase Linearity( $f_0 \pm 7\text{MHz}$ )

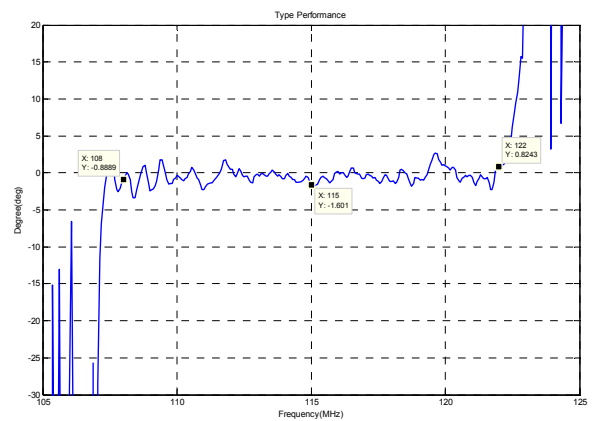

Horizontal: 5MHz/Div Vertical: 5deg/Div

Smith Chart S11

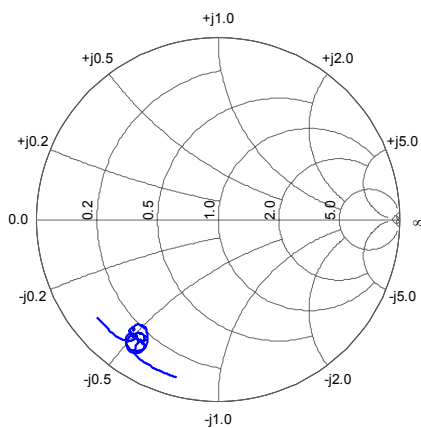

Smith Chart S22

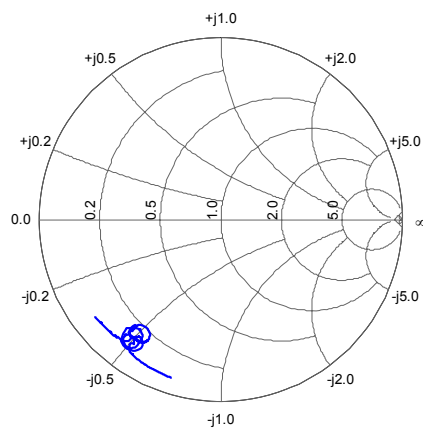

**SIPAT Co., Ltd.**  
( CETC No.26 Research Institute )  
#14 Nanping Huayuan Road,  
Chongqing, China, 400060

Part Number	LBN11536	
Rev. Date	2007-11-13	
Ver.	2.0	Page 3/3