

Specifications

Parameter	Unit	Minimum	Typical	Maximum
Center Frequency	MHz	106.23	106.31	106.39
Insertion Loss	dB		22	23.5
3dB Bandwidth	MHz	2.46	2.53	
30 dB Bandwidth	MHz		3.18	3.26
40dB Bandwidth	MHz		3.27	3.56
5 0dB Bandwidth	MHz		3.33	3.86
Passband Variation	dB		0.9	1.2
Absolute Delay	usec		3.6	
Ultimate Rejection	dB	47	50	
Substrate Material			Quartz	
Ambient Temperature	°C		25	
Package Size		DIP2712 (27.2x12.7x5.2mm ³)		

Notes:

1. All specifications are based on the test circuit shown
2. In production, devices will be tested at room temperature to a guardbanded specification to ensure electrical compliance over temperature
3. Electrical margin has been built into the design to account for the variations due to temperature drift and manufacturing tolerances
4. This is the optimum impedance in order to achieve the performance show

Matching Configuration

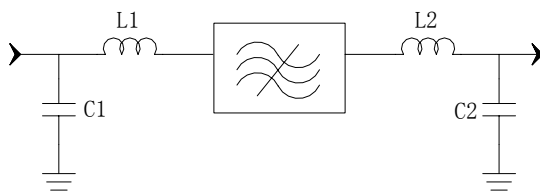

L1=100+33nH L2=82+33nH
C1=56pF C2=33pF

Source/Load Impedance=50 ohm

Notes - Component values may change depending
on board layout.

	SIPAT Co., Ltd. (CETC No. 26 Research Institute) Nanping Huayuan Road No. 14 Chongqing, China, 400060	Part Number	LBS10602	
		Rev. Date	2005-4-21	
		Rev.	1.0	Page

Package Dimension

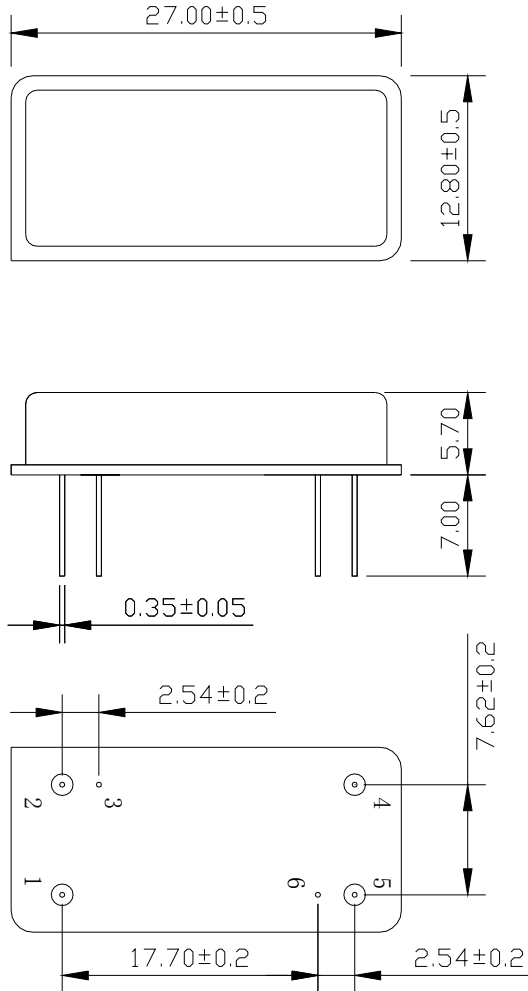

Pin 1: input
Pin 5: output
Others: Grounded

	SIPAT Co., Ltd. (CETC No. 26 Research Institute) Nanping Huayuan Road No. 14 Chongqing, China, 400060	Part Number	LBS10602	
		Rev. Date	2005-4-21	
		Rev.	1.0	Page

Typical Performance

Frequency Respond

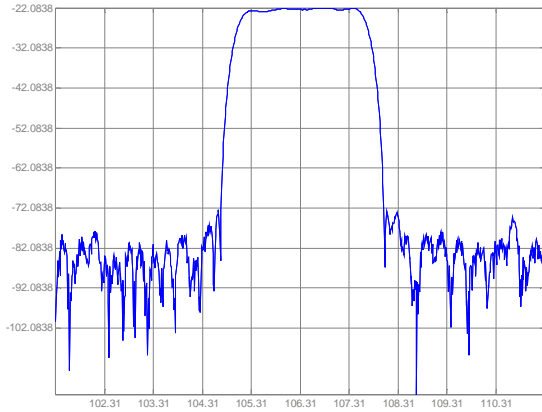

Passband Respond

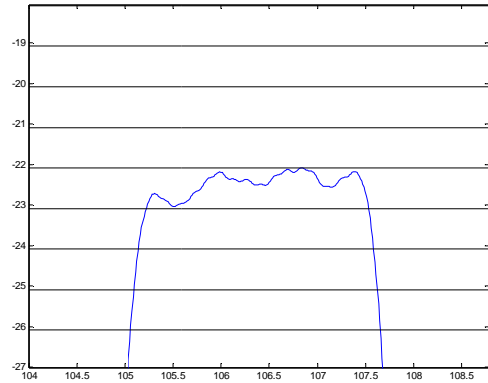

Group Delay Variation($f_0 \pm 984\text{KHz}$)

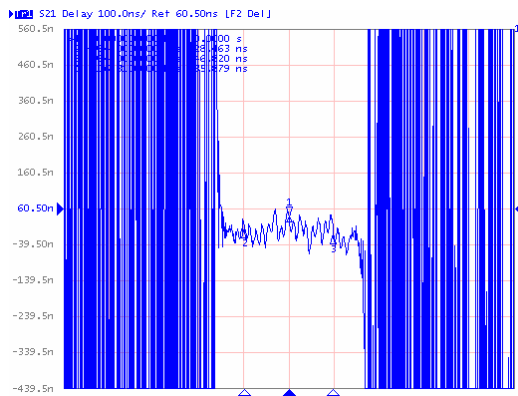

Phase Linearity($f_0 \pm 984\text{KHz}$)

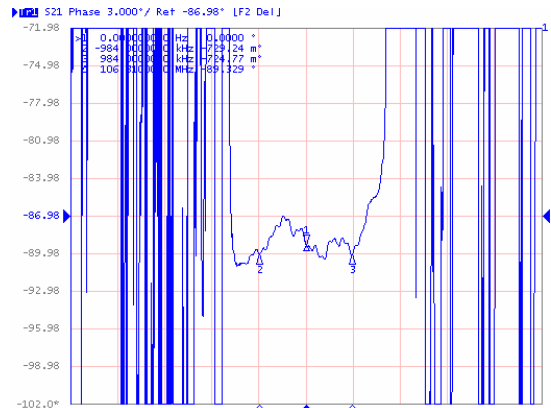

Simth Chart S11

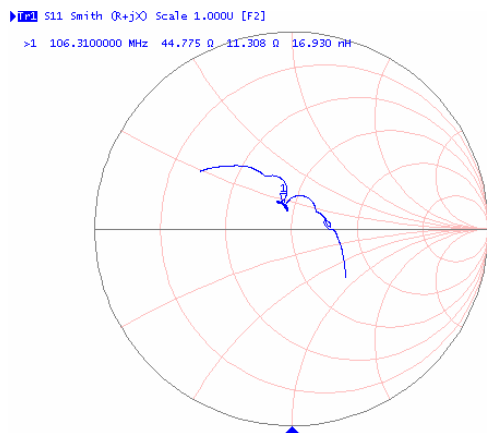

Simth Chart S22

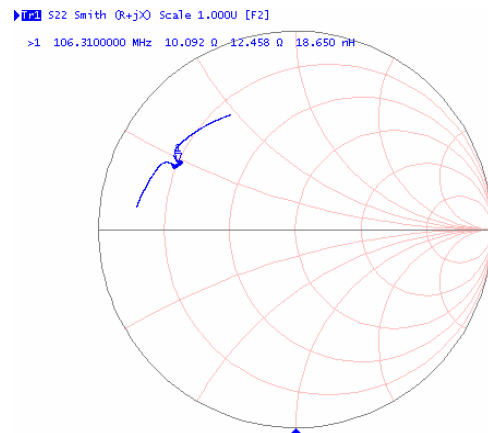

SIPAT Co., Ltd.
(CETC No. 26 Research Institute)
Nanping Huayuan Road No. 14
Chongqing, China, 400060

Part Number	LBS10602	
Rev. Date	2005-4-21	
Rev.	1.0	Page 3/3