

Specifications

Parameter	Unit	Minimum	Typical	Maximum
Center Frequency	MHz	113.965	114	114.035
Insertion Loss	dB	-	8.1	10
1 dB Bandwidth	MHz	0.45	0.48	-
20 dB Bandwidth	MHz	-	1.535	1.55
40 dB Bandwidth	MHz	-	2.1	2.5
Passband Variation	dB	-	0.2	-
Absolute Delay	usec	-	1.28	-
Phase Linearity($f_0 \pm 0.225\text{MHz}$)	deg	-	2	5
Group Delay Variation	nsec			
$f_0 \pm 0.15\text{MHz}$			25	100
$f_0 \pm 0.25\text{MHz}$			52	200
Ultimate Rejection ($f_0 \pm 3\text{MHz}$)	dB	42	45	
Material Temperature coefficient	KHz/°C		0.114	
Operating temperature	°C		-35~75	
Substrate Material			Quartz	
Ambient Temperature	°C		25	
Package Size			SMD 13.3*6.5	

Notes:

1. All specifications are based on the test circuit shown
2. In production, devices will be tested at room temperature to a guardbanded specification to ensure electrical compliance over temperature
3. Electrical margin has been built into the design to account for the variations due to temperature drift and manufacturing tolerances
4. This is the optimum impedance in order to achieve the performance show

Matching Configuration

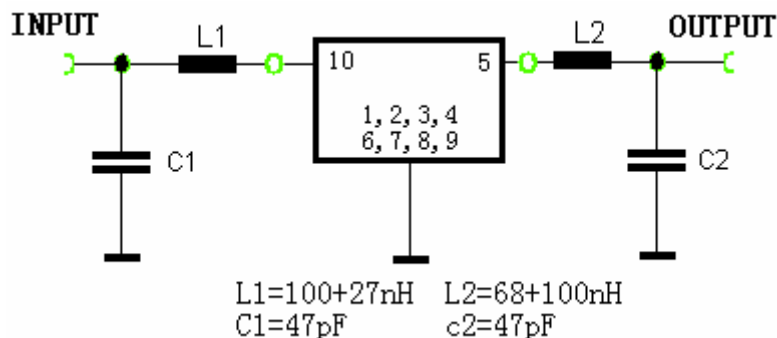

Actual matching values may vary due to PCB layout and parasitics

	SIPAT Co., Ltd. (CETC No. 26 Research Institute) Nanping Huayuan Road No. 14 Chongqing, China, 400060	Part Number	LBS11401		
		Rev. Date	2004-11-12		
		Rev.	1.0	Page 1/3	

Package Dimension

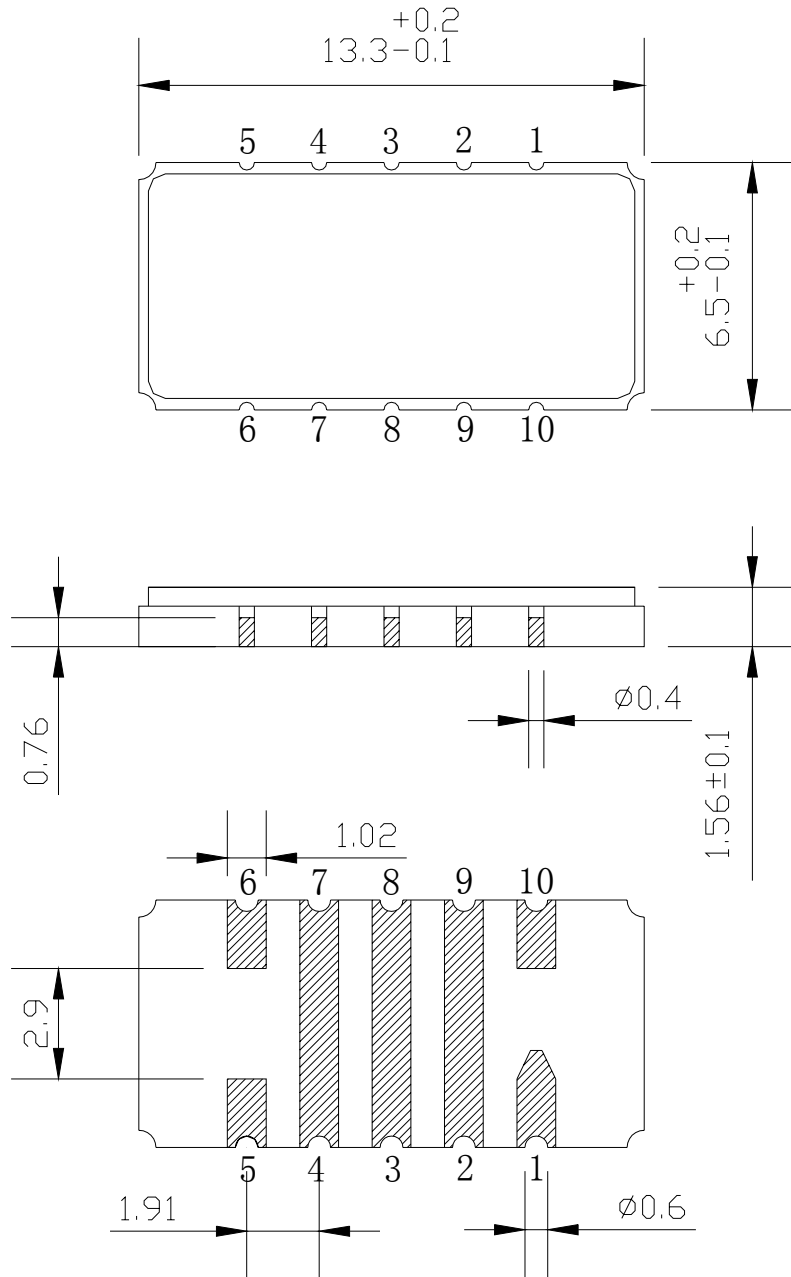

SIPAT Co., Ltd.
(CETC No. 26 Research Institute)
Nanping Huayuan Road No. 14
Chongqing, China, 400060

Part Number	LBS11401	
Rev. Date	2004-11-12	
Rev.	1.0	Page 2/3

Typical Performance

Frequency Response

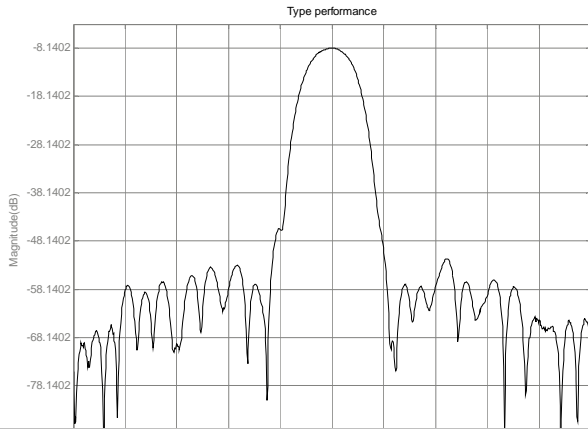

Passband Response

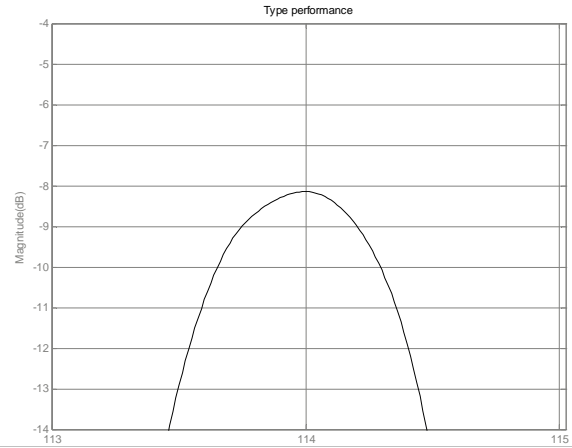

Group delay variation($f_0 \pm 150k$)

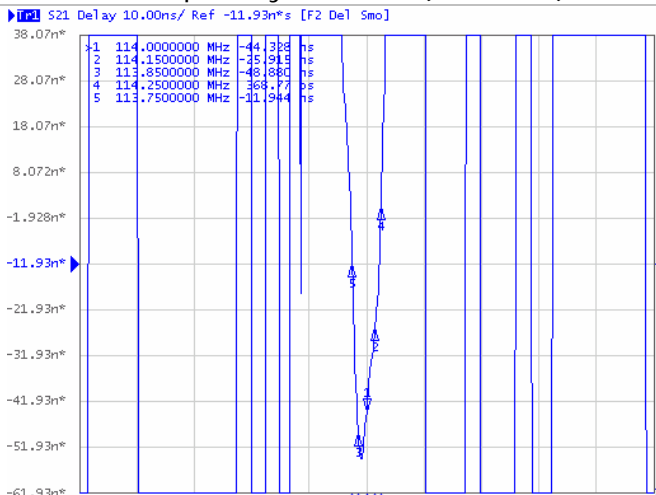

Phase Linearity($f_0 \pm 225k$)

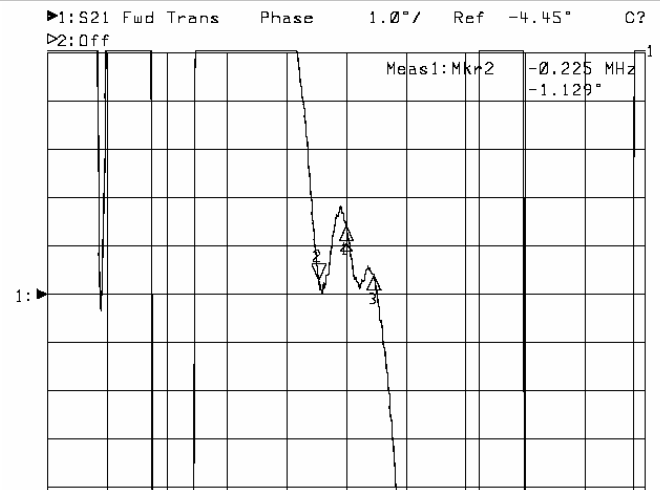

Smith Chart S11

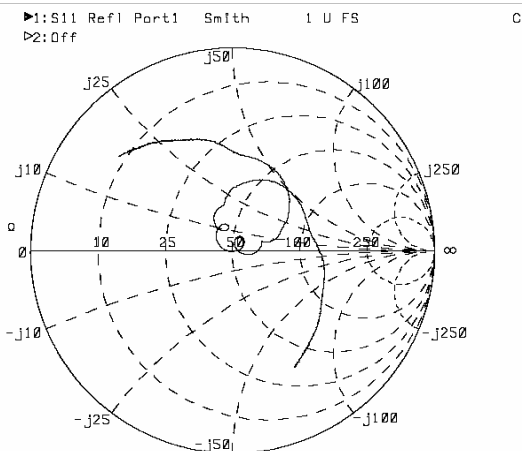

Smith Chart S22

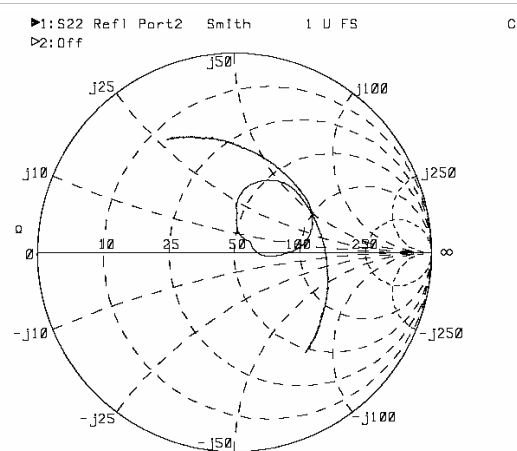

SIPAT Co., Ltd.
(CETC No. 26 Research Institute)
Nanping Huayuan Road No. 14
Chongqing, China, 400060

Part Number	LBS11401	
Rev. Date	2004-11-12	
Rev.	1.0	Page 3/3