



Features

- ◇ For IF SAW filter
- ◇ High attenuation
- ◇ Single-ended operation
- ◇ Dual In-line Package
- ◇ RoHS compliant (2002/95/EC), Pb-free

Specifications

Parameter	Unit	Minimum	Typical	Maximum
Center Frequency	MHz	139.8	140	140.2
Insertion Loss	dB	-	26.3	28
1 dB Bandwidth	MHz	5.6	5.8	-
3 dB Bandwidth	MHz	6	6.21	-
40 dB Bandwidth	MHz	-	7.8	8.4
50 dB Bandwidth	MHz	-	8.05	9
Passband Variation	dB	-	0.6	1
Phase Linearity($f_0 \pm$ MHz)	deg	-	4	-
Group Delay Variation($f_0 \pm$ MHz)	nsec	-	30	110
Absolute Delay	usec	-	1.92	-
Ultimate Rejection	dB	50	51	-
Material Temperature coefficient	KHz/°C	0.14		
Substrate Material	-	Qz		
Ambient Temperature	°C	25		
Operating Temperature Range	°C	-40	-	+85
Storage Temperature Range	°C	-45	-	+105
DC Voltage	V	0		
Input Power	dBm	-	-	10
ESD Class	-	1A		
Package Size	DIP2212 (22.2x12.8x4.7mm3)			

Notes:

1. All specifications are based on the test circuit shown;
2. In production, all specifications are measured by Agilent Network analyzer and full 2 port calibration at room temperature;
3. Electrical margin has been built into the design to account for the variations due to temperature drift and manufacturing tolerances;
4. This is the optimum impedance in order to achieve the performance show.

	SIPAT Co., Ltd. (CETC No.26 Research Institute) #14 Nanping Huayuan Road, Chongqing, China, 400060	Part Number	LBS14021	
		Rev. Date	2009-02-13	
		Ver.	1.1	Page

Matching Configuration

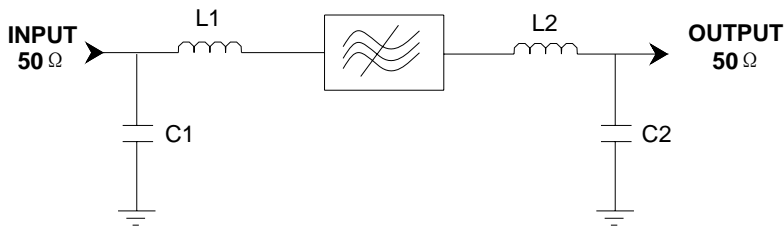

L1=(150+27)nH L2=180nH
C1=18pF C2=22pF
Source/Load Impedance=50 ohm

Notes - Component values may change depending
on board layout.

Package Dimension

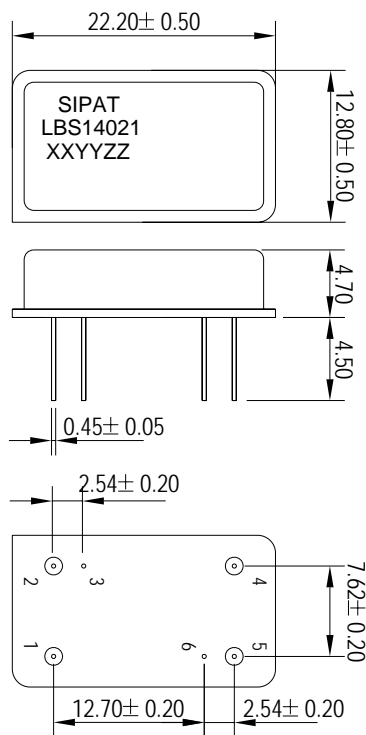

Pad Configuration:

Input 1
Output 5
Ground All Others

Marking Configuration:

- 1) SIPAT: Manufacturer Name
- 2) LBS14021: Part Number
- 3) XXYY: Date(Year/month)
- 4) ZZ: Identified Code

Package: DIP2212

Unit: mm



SIPAT Co., Ltd.
(CETC No.26 Research Institute)
#14 Nanping Huayuan Road,
Chongqing, China, 400060

Part Number	LBS14021	
Rev. Date	2009-02-13	
Ver.	1.1	Page 2/3



Typical Performance

Frequency Respond

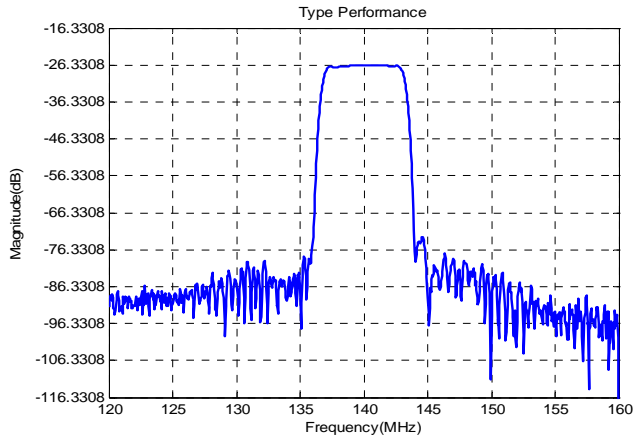

Horizontal: 5MHz/Div

Vertical: 10dB/Div

Passband Respond

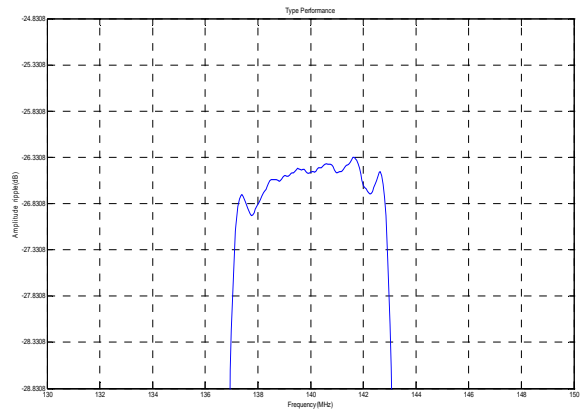

Horizontal: 2MHz/Div

Vertical: 0.5dB/Div

Group Delay Variation($f_0 \pm 3\text{MHz}$)

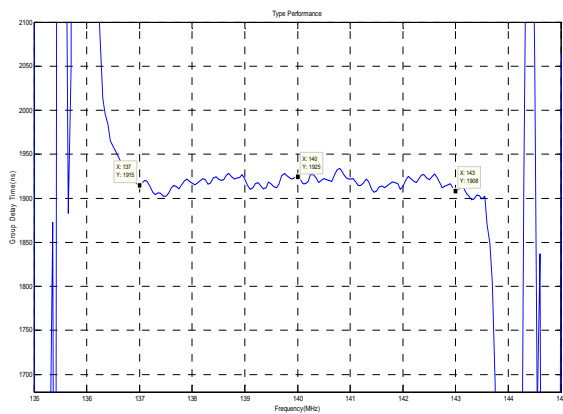

Horizontal: 1MHz/Div

Vertical: 50ns/Div

Phase Linearity($f_0 \pm 3\text{MHz}$)

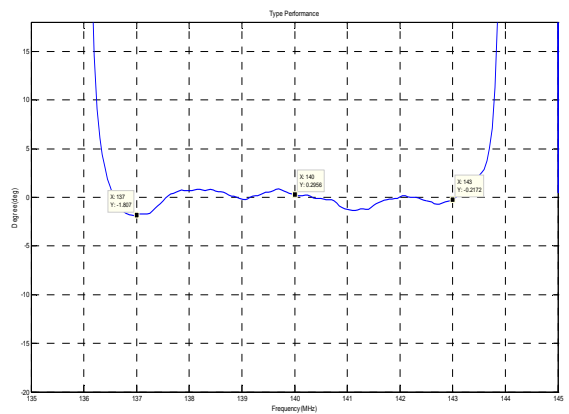

Horizontal: 1MHz/Div

Vertical: 5deg/Div

Smith Chart S11

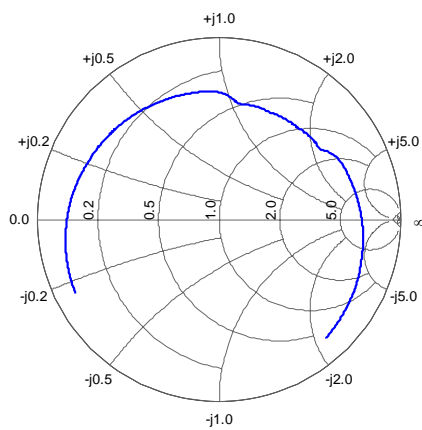

Smith Chart S22

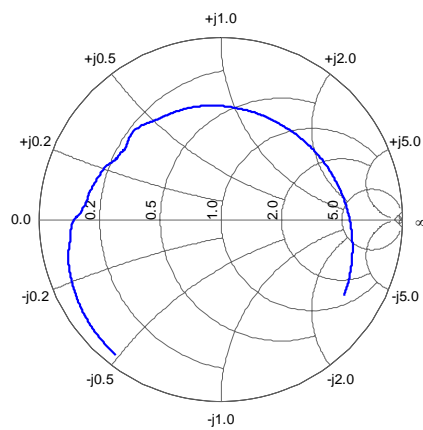

SIPAT Co., Ltd.
(CETC No.26 Research Institute)
#14 Nanping Huayuan Road,
Chongqing, China, 400060

Part Number

LBS14021

Rev. Date

2009-02-13

Ver.

1.1

Page 3/3