



### Features

- ◇ For IF SAW filter
- ◇ High attenuation
- ◇ Single-ended operation
- ◇ Dual In-line Package
- ◇ No matching required for operation at 50Ω
- ◇ RoHS compliant (2002/95/EC), Pb-free

### Specifications

Parameter	Unit	Minimum	Typical	Maximum
Center Frequency	MHz	139.9	140	140.1
Insertion Loss	dB	-	23.7	25
1 dB Bandwidth	MHz	0.77	0.9	-
3 dB Bandwidth	MHz	1	1.14	-
40 dB Bandwidth	MHz	-	1.95	2.2
Passband Variation	dB	-	0.2	0.5
Absolute Delay	usec	-	3.21	4
Group Delay Variation( $f_0 \pm 0.5\text{MHz}$ )	nsec	-	100	270
Ultimate Rejection( $f_0 \pm 1.2\text{MHz}$ )	dB	50	54	-
Material Temperature coefficient	KHz/°C	0.14		
Substrate Material	-	QZ		
Ambient Temperature	°C	25		
Operating Temperature Range	°C	-40	-	+85
Storage Temperature Range	°C	-45	-	+105
DC Voltage	V	0		
Input Power	dBm	-	-	10
ESD Class	-	1A		
Package Size	DIP2712 (27.0x12.8x4.7mm <sup>3</sup> )			

#### Notes:

1. All specifications are based on the test circuit shown;
2. In production, all specifications are measured by Agilent Network analyzer and full 2 port calibration at room temperature;
3. Electrical margin has been built into the design to account for the variations due to temperature drift and manufacturing tolerances;
4. This is the optimum impedance in order to achieve the performance show.

	<b>SIPAT Co., Ltd.</b> ( CETC No.26 Research Institute ) #14 Nanping Huayuan Road, Chongqing, China, 400060	Part Number	LBS14028	
		Rev. Date	2008-03-11	
		Ver.	2.0	Page

### Matching Configuration



Source/Load Impedance=50 ohm

Notes - Component values may change depending on board layout.

### Package Dimension

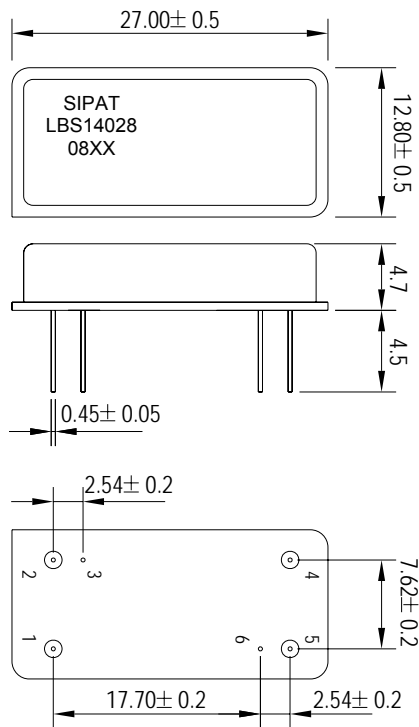

#### Pad Configuration:

Input 1  
 Output 5  
 Ground All Others

#### Marking Configuration:

- 1) SIPAT: Manufacturer Name
- 2) LBS14028: Part Number
- 3) 08XX: Date Code

Package: DIP2712

Unit: mm



**SIPAT Co., Ltd.**  
 ( CETC No.26 Research Institute )  
 #14 Nanping Huayuan Road,  
 Chongqing, China, 400060

Part Number	LBS14028	
Rev. Date	2008-03-11	
Ver.	2.0	Page 2/3



Typical Performance

Frequency Respond

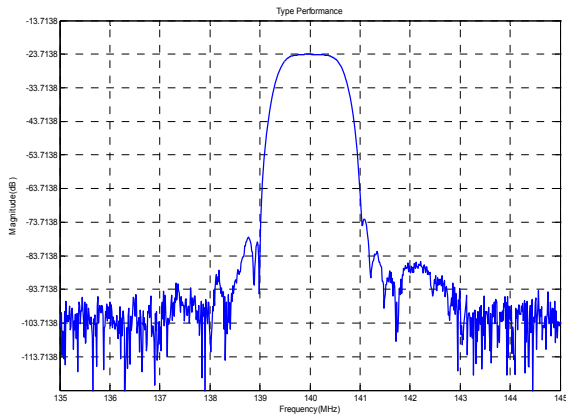

Horizontal: 1MHz/Div Vertical: 10dB/Div

Passband Respond

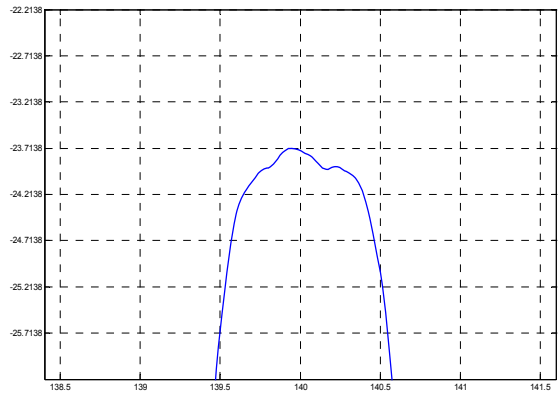

Horizontal: 0.5MHz/Div Vertical: 0.5dB/Div

Group Delay Variation(f0±0.5MHz)

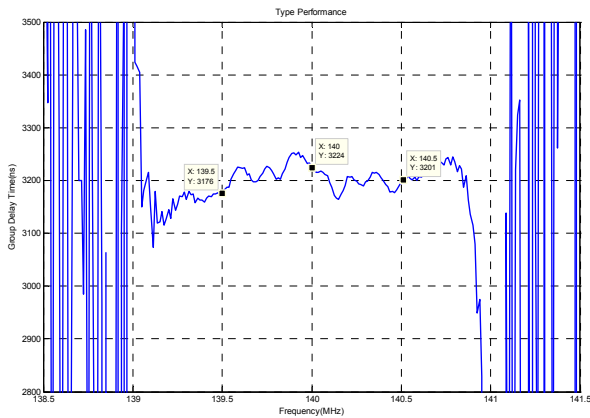

Horizontal: 0.5MHz/Div Vertical: 100ns/Div

Phase Linearity(f0±0.5MHz)

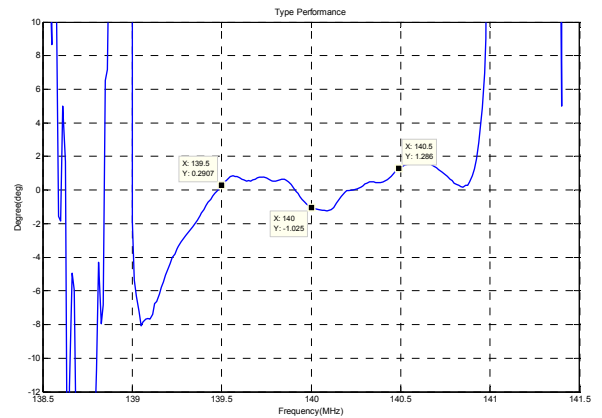

Horizontal: 0.5MHz/Div Vertical: 2deg/Div

Smith Chart S11

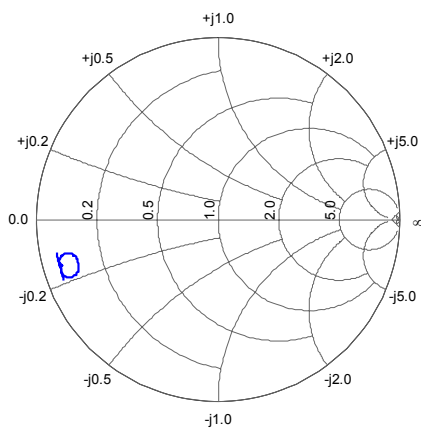

Smith Chart S22

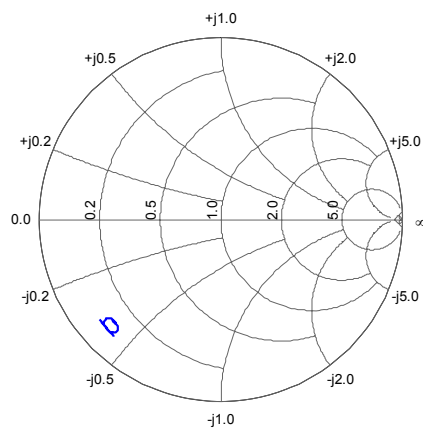

SIPAT Co., Ltd.  
( CETC No.26 Research Institute )  
#14 Nanping Huayuan Road,  
Chongqing, China, 400060

Part Number	LBS14028	
Rev. Date	2008-03-11	
Ver.	2.0	Page 3/3