

Specifications

Parameter	Unit	Minimum	Typical	Maximum
Center Frequency	MHz	114.92	115	115.08
Insertion Loss	dB	—	26.6	27
3 dB Bandwidth	MHz	5.6	5.63	—
18dB Bandwidth	MHz	—	6.13	6.2
40 dB Bandwidth	MHz	—	6.39	6.6
50 dB Bandwidth	MHz	—	6.45	7
Passband Variation	dB	—	0.9	1.5
Absolute Delay	usec	—	3.7676	—
Group Delay Variation($f_0 \pm 2.5\text{MHz}$)	nsec	—	100	200
Ultimate Rejection	dB	45	49	—
Material Temperature coefficient	KHz/°C	-2.07		
Ambient Temperature	°C	25		
Package Size	DIP2712 (27.0x12.8x4.7mm3)			

Notes:

1. All specifications are based on the test circuit shown
2. In production, devices will be tested at room temperature to a guardbanded specification to ensure electrical compliance over temperature
3. Electrical margin has been built into the design to account for the variations due to temperature drift and manufacturing tolerances
4. This is the optimum impedance in order to achieve the performance show

Matching Configuration

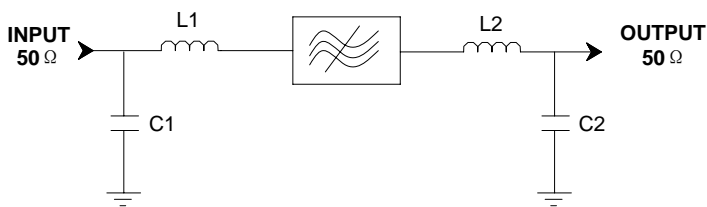

L1=47nH L2=56nH
C1=C2=36pF

Source/Load Impedance=50 ohm

Notes - Component values may change depending on board layout.



SIPAT Co., Ltd.
(CETC No. 26 Research Institute)
Nanping Huayuan Road No. 14
Chongqing, China, 400060

Part Number	LBT11541	
Rev. Date	2005-9-23	
Rev.	1.0	Page 1/3

Package Dimension

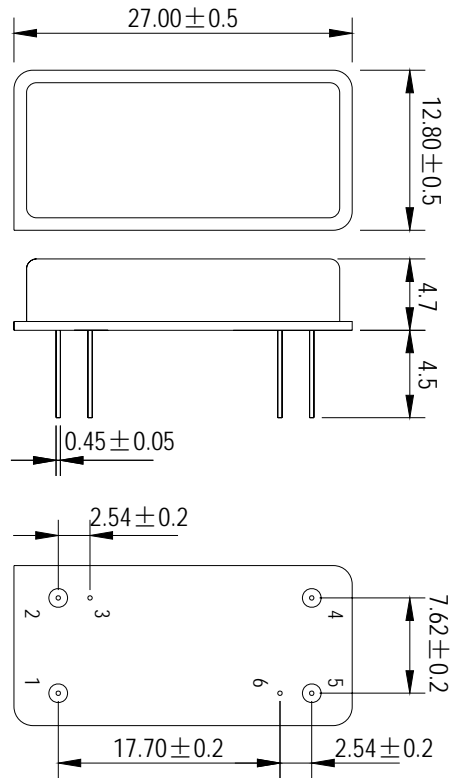

Input:1
Output:5



SIPAT Co., Ltd.
(CETC No. 26 Research Institute)
Nanping Huayuan Road No. 14
Chongqing, China, 400060

Part Number	LBT11541	
Rev. Date	2005-9-23	
Rev.	1.0	Page 2/3

Typical Performance

Frequency Respond

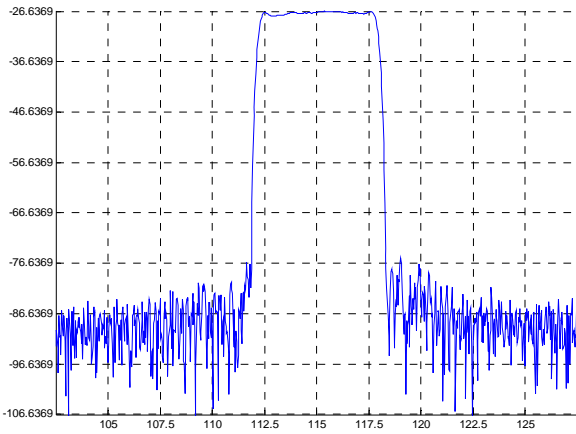

Passband Respond

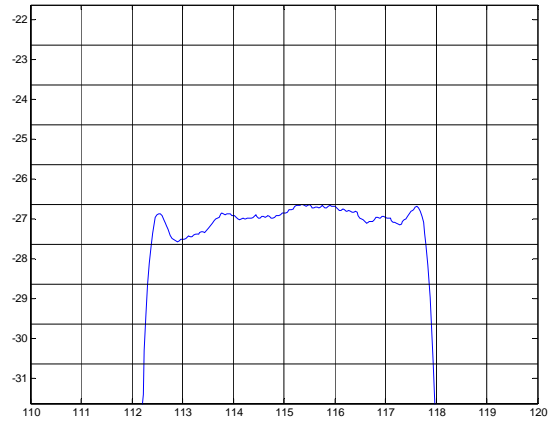

Group Delay Variation($f_0 \pm 2.5\text{MHz}$)

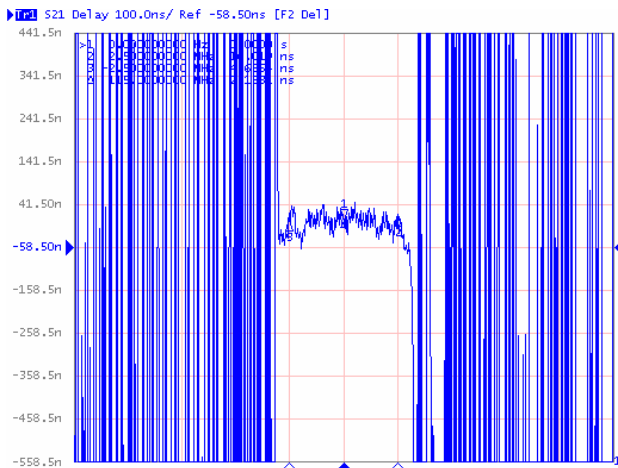

Phase Linearity($f_0 \pm 2.5\text{MHz}$)

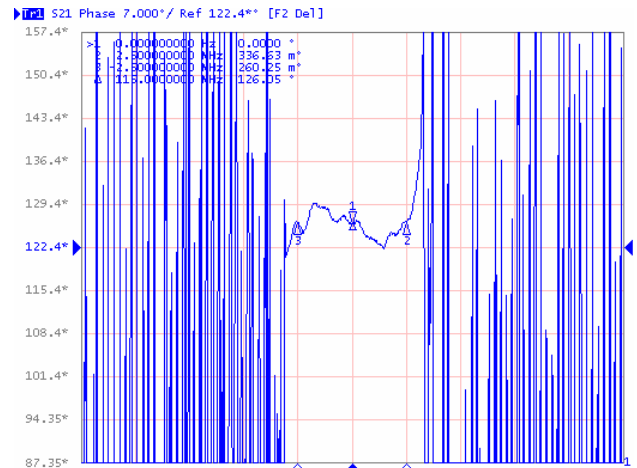

Smith Chart S11

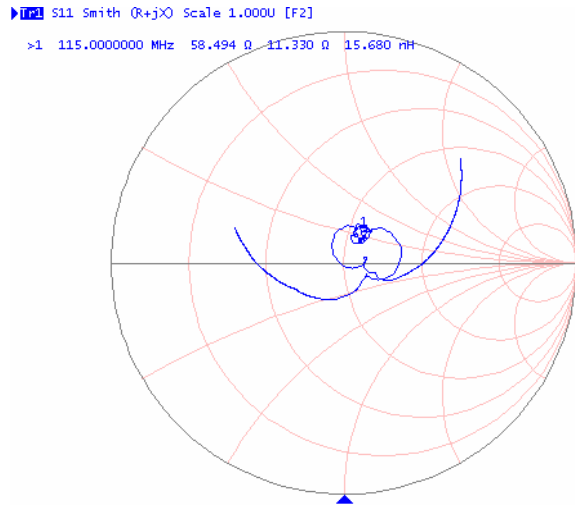

Smith Chart S22

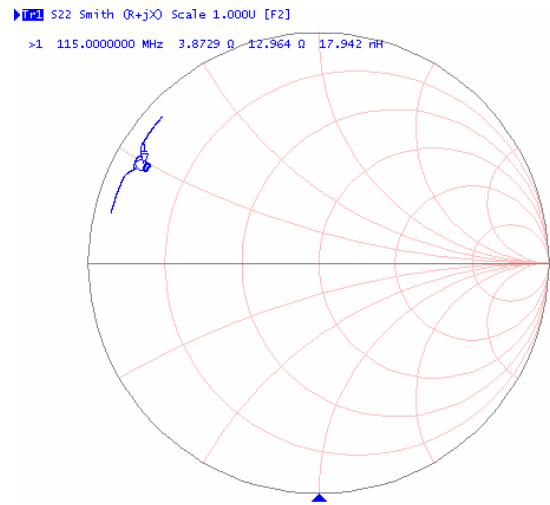

SIPAT Co., Ltd.
(CETC No. 26 Research Institute)
Nanping Huayuan Road No. 14
Chongqing, China, 400060

Part Number

LBT11541

Rev. Date

2005-9-23

Rev.

1.0

Page 3/3