



Features

- ◇ For IF SAW filter
- ◇ High attenuation
- ◇ Single-ended operation
- ◇ Dual In-line Package
- ◇ RoHS compliant (2002/95/EC), Pb-free

Specifications

Parameter	Unit	Minimum	Typical	Maximum
Center Frequency	MHz	119.875	120	120.125
Insertion Loss	dB	-	24.5	29
1.5 dB Bandwidth	MHz	6.05	6.08	-
3 dB Bandwidth	MHz	-	6.25	-
18 dB Bandwidth	MHz	-	6.8	6.95
25 dB Bandwidth	MHz	-	6.92	7.15
30 dB Bandwidth	MHz	-	6.99	7.25
40 dB Bandwidth	MHz	-	7.11	8
Passband Variation	dB	-	0.7	1.5
Absolute Delay	usec	-	2.74	2.75
Ultimate Rejection	dB	40	43	-
Material Temperature coefficient	KHz/°C	-2.16		
Substrate Material	-	112LT		
Ambient Temperature	°C	25		
Operating Temperature Range	°C	-40	-	+85
Storage Temperature Range	°C	-45	-	+105
DC Voltage	V	0		
Input Power	dBm	-	-	10
ESD Class	-	1		
Package Size	DIP3512 (35.0x12.8x4.7mm3)			

Notes:

1. All specifications are based on the test circuit shown;
2. In production, all specifications are measured by Agilent Network analyzer and full 2 port calibration at room temperature;
3. Electrical margin has been built into the design to account for the variations due to temperature drift and manufacturing tolerances;
4. This is the optimum impedance in order to achieve the performance show.

	SIPAT Co., Ltd. (CETC No.26 Research Institute) #14 Nanping Huayuan Road, Chongqing, China, 400060	Part Number	LBT12005	
		Rev. Date	2008-01-02	
		Ver.	3.0	Page

Matching Configuration

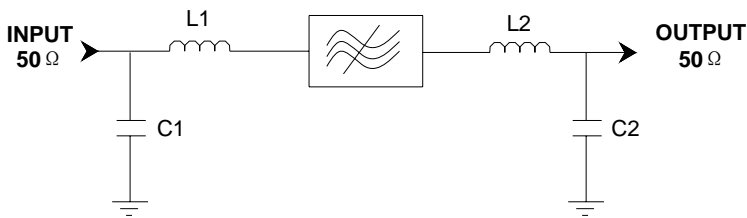

L1=L2=27nH
C1=82pF C2=56pF
Source/Load Impedance=50 ohm

Notes - Component values may change depending
on board layout.

Package Dimension

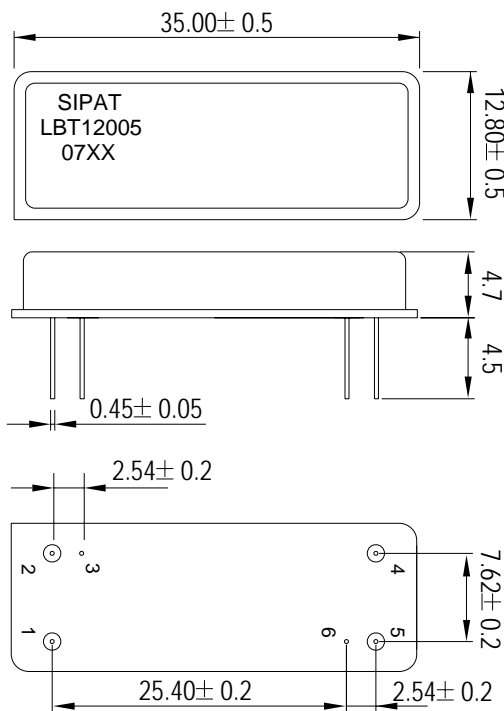

Pad Configuration:

Input 1
Output 5
Ground All Others

Marking Configuration:

- 1) SIPAT: Manufacturer Name
- 2) LBT12005: Part Number
- 3) 07XX: Date Code

Package: DIP3512

Unit: mm



SIPAT Co., Ltd.
(CETC No.26 Research Institute)
#14 Nanping Huayuan Road,
Chongqing, China, 400060

Part Number	LBT12005	
Rev. Date	2008-01-02	
Ver.	3.0	Page 2/3



Typical Performance

Frequency Respond

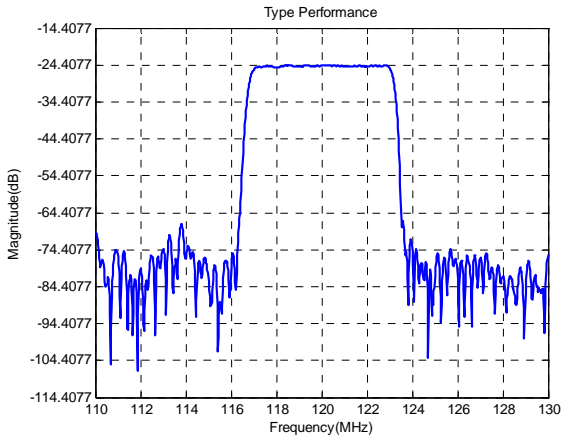

Horizontal: 2MHz/Div Vertical: 10dB/Div

Passband Respond

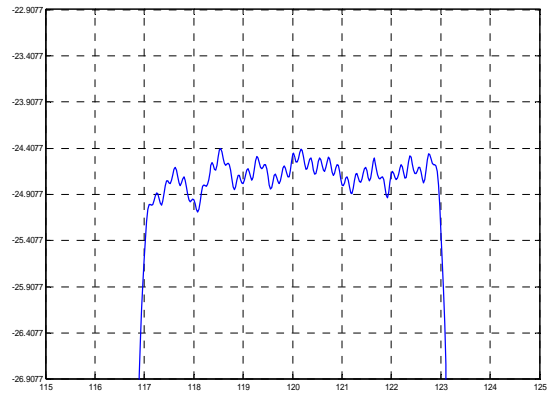

Horizontal: 1MHz/Div Vertical: 0.5dB/Div

Group Delay Variation($f_0 \pm 3\text{MHz}$)

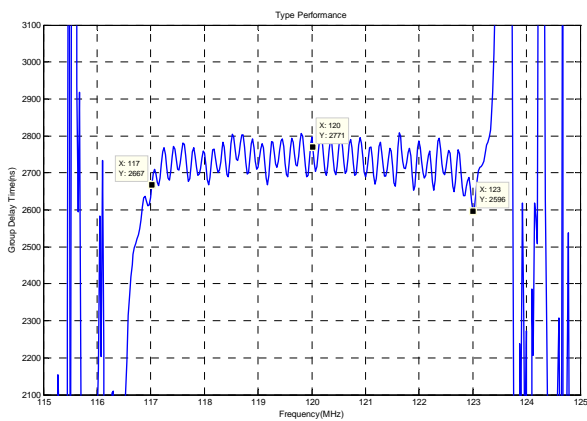

Horizontal: 1MHz/Div Vertical: 100ns/Div

Phase Linearity($f_0 \pm 3\text{MHz}$)

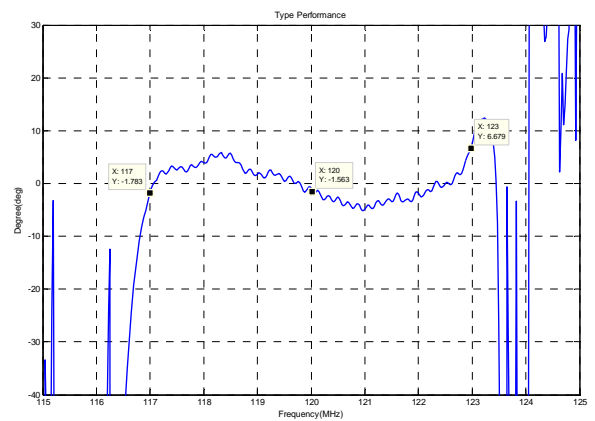

Horizontal: 1MHz/Div Vertical: 10deg/Div

Smith Chart S11

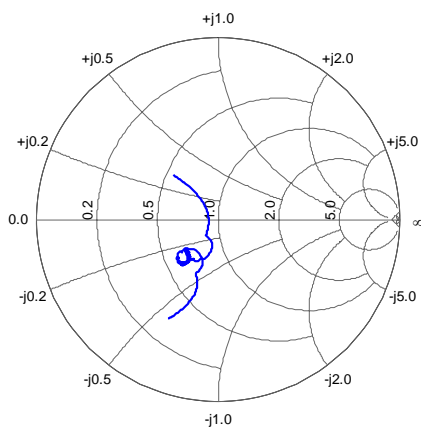

Smith Chart S22

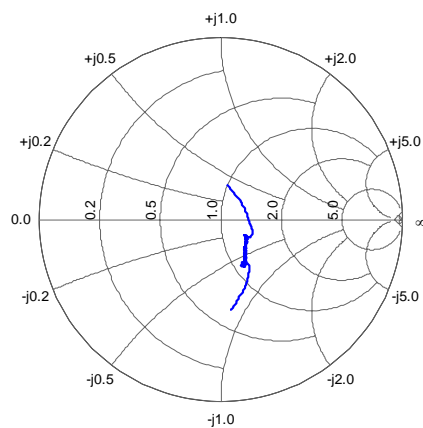

SIPAT Co., Ltd.
(CETC No.26 Research Institute)
#14 Nanping Huayuan Road,
Chongqing, China, 400060

Part Number	LBT12005	
Rev. Date	2008-01-02	
Ver.	3.0	Page 3/3